

DENON[®]

AH-GC25W

Wireless Over-Ear Headphone

Owner's Manual



Preparation

Unpacking	4
Features	5
Sound quality	5
Functions	5
Telephone Calls	6
Part names and functions	7
Charging / Battery status	8
Wearing	10
Switching Audio Guidance	11

Connections

Bluetooth operation	13
Pairing	13
Connecting	13
1: Connecting to the headphones for the first time	14
2: Reconnecting paired devices	16
Simultaneously connecting multiple Bluetooth devices (Multipoint function)	17
Connecting to a computer via USB	19

Operation

Listening to music	20
Listening to music using a Bluetooth connection	20
Listening to music using the audio cable	22
Listening to music on a computer via USB	23
Conducting phone calls	25
Making a call	25
Answering an incoming call	25
Ending a call	25
Using the call waiting function	26
Ignoring an incoming call	26
Switching a call from the headphones to a mobile phone	26
Other operations	27
Turning the power off	27
Information	28
Audio Playback and Phone Calls on a Bluetooth Device	28
Deleting pairing information	28



Troubleshooting

Troubleshooting	29
Power does not turn on / power is turning off automatically	29
The device cannot be charged	29
No sound comes out	30
Sound is distorted, noisy, or cuts in and out	30
Cannot play media using Bluetooth	31
Cannot make a phone call	32

Appendix

Precautions for Use	33
Disposal of these headphones	34
Trademark information	34
Specifications	35









Thank you for purchasing this product.

To ensure proper operation, please read this Owner's Manual carefully before using the product.

Unpacking

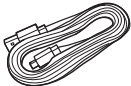
Check that all of these are present before using this device.

 <p>Quick Start Guide</p>	 <p>Safety Instructions</p>	 <p>Audio cable (approx. 1.3 m)</p>	 <p>Audio cable (approx. 1.3 m) with remote control mic</p>
 <p>USB cable (Micro-B connector, approximately 1.2 m)</p>	 <p>Carrying pouch</p>		



Features

Sound quality

- These headphones are compatible with a wide range of codecs, including the high sound quality codecs aptX HD, AAC and SBC. These headphones automatically select the optimum compatible codec for your Bluetooth device (smartphone or tablet) so you can enjoy high-grade wireless sound.

Functions

- You can enjoy listening to music wirelessly by connecting these headphones to your Bluetooth device. Playback operations and volume adjustment can be performed for the paired audio device using the headphones.
- You can connect to an audio device that is not equipped with Bluetooth using the supplied cable, or in case Bluetooth is not allowed or the battery runs out. The included audio cable with a remote control mic is compatible with operations and calls on playback devices.
- Connect to a computer with the included USB cable to enjoy high-quality music played from your computer. Music can be played back from your computer even while the headphones are charging so that music can be enjoyed without worrying about the battery running out.



Telephone Calls

- You can also make hands-free phone calls by pairing these headphones to a Bluetooth compatible mobile phone. Equipped with Qualcomm® cVc™ technology that suppresses echoes, enabling low-noise phone calls.



Part names and functions

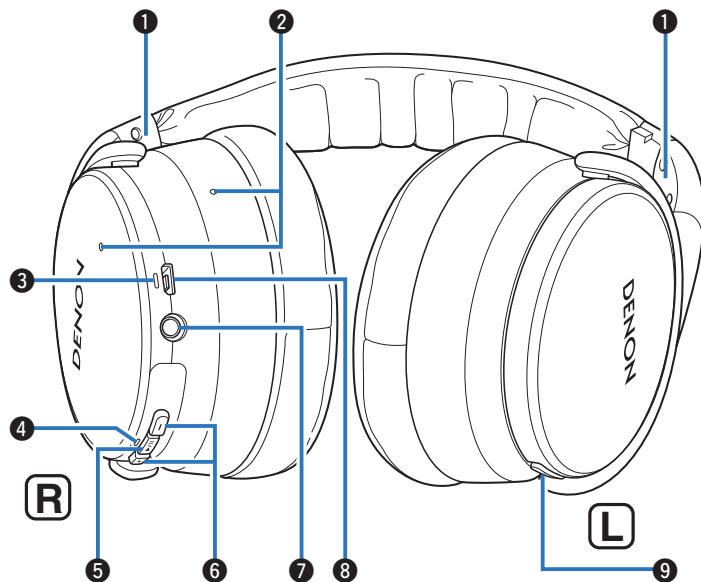

- ❶ L/R Indicators
- ❷ Call microphones
- ❸ Charging LED
- ❹ Bluetooth LED
- ❺ Control button (▶/||)

 - Pairs the headphones with Bluetooth devices. (☞ p. 14)
 - Connects to Bluetooth devices. (☞ p. 16)
 - Turns the power off. (☞ p. 27)
 - Performs playback operations. (☞ p. 20)

- ❻ Volume buttons (+/-) (☞ p. 21)
- ❼ Stereo mini jack (2.5 mm)
Connects to playback devices using the included audio cable. (☞ p. 22)
- ❽ USB port (Micro-B)
- ❾ Call button
 - Indicates the remaining battery power. (☞ p. 9)
 - Controls call operations on the mobile phones connected via Bluetooth. (☞ p. 25)



Charging / Battery status

Connect the headphones to a computer or USB AC adapter (sold separately) using the supplied dedicated USB cable to charge the battery.

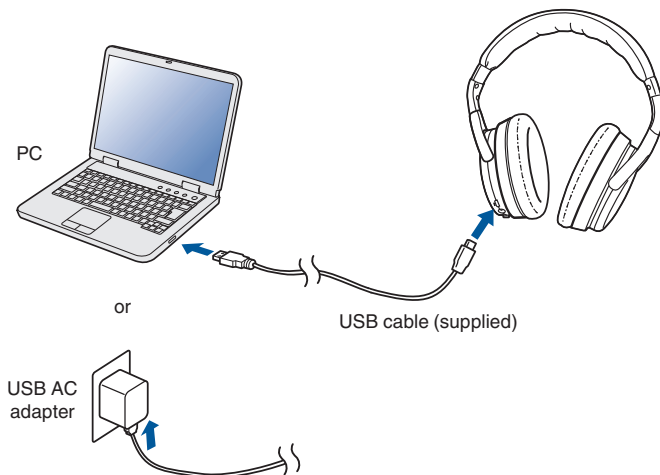

The charging status can be checked from the charging LED on headphones.

Charging status	Color of charging LED	
Charging	Red	
Fully charged	Green	



- When using the headphones for the first time after purchase or when the remaining power of the rechargeable battery is low, charge the battery.
- You can connect the headphones to a device using the supplied audio cable to enjoy listening to music even if the battery is drained. (☞ p. 22)
- The headphones can be used for approximately 30 hours of music playback when fully charged.
- It takes approximately 2 hours to fully charge the rechargeable battery from the state of no remaining battery power.
- You can listen to music from a paired Bluetooth device or make phone calls even during charging. In this case, noise may occur in the audio from the headphones depending on the type of computer used.
- When the USB cable is connected to this unit, the headphones disconnect from Bluetooth and enter charging mode. Reconnect to Bluetooth to start Bluetooth playback again. (☞ p. 13)
- The usable time of the headphones differs depending on the temperature of the environment in which they are used and method of use.

NOTE

- When connecting the USB cable to the USB port, be sure to match the cable connector with the shape of the socket. Forcing the connector into the socket will cause damage.
- The rating of the charging output should be DC 5 V, 2.4 A or less.



■ Checking the remaining battery power

The remaining power of the rechargeable battery can be checked from the number of alert sounds or audio guidance. It can also be checked from the number of times the charging LED flashes. Press and hold the ►/|| button for approximately 2 second to turn the power on, then press the call button twice when a call is not in progress.

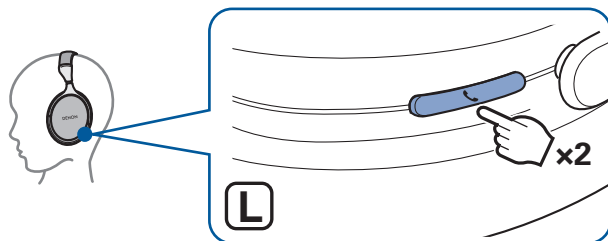

Number of alert sounds	Number of times the charging LED flashes	Remaining time of rechargeable battery
Four times	Four times	Approx. 30 hours
Three times	Three times	Approx. 15 hours
Twice	Twice	Approx. 5 hours
Once	Once	Less than 1 hours



- When the remaining power of the rechargeable battery is running low, the charging LED flashes at approximately 3-second intervals together with an alert sound.
- You can also check the remaining power of the rechargeable battery on an iPhone. (*)
 - * The remaining power of the rechargeable battery can be displayed as a percentage (%) on an iPhone, but this number is an approximate value.



Wearing

Adjust the slider to the preferred length.

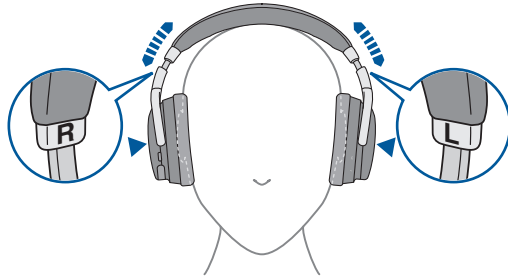

- In order to hear the best quality sound, be sure that the ear pads correctly cover both the left and right ears. If there are gaps between your ears and the headphone ear pads, sound will leak and the bass level will be reduced.

NOTE

- Be careful not to trap your fingers, etc. in the moving parts.
- Do not pull the slider too forcefully.



Switching Audio Guidance

You will be notified when an operation has been correctly completed via the audio guidance or an alert sound.

You can switch to audio guidance in your preferred language or use only an alert sound for guidance.

- 1 While the power is on and a call is not in progress, press and hold the call button and volume “+” button together for approximately 1 second.**

The options switch between the audio guidance languages or only alert sounds in the following order while the buttons are pressed.

English / Japanese / German / French / Italian / Spanish / Chinese / Alert sounds (Default: English)

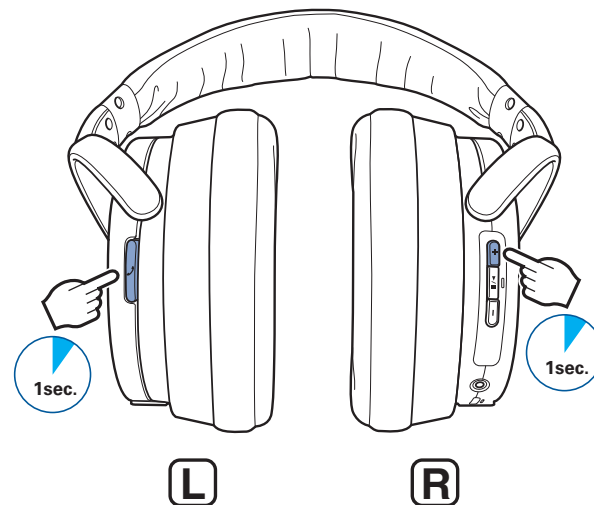

2 Release the buttons when the options have switched to your desired setting.

This commits the audio guidance setting.

■ Adjusting the audio guidance volume

The audio guidance volume can be adjusted between 3 levels.

1 Press and hold the volume “+” button and volume “-” button together for approximately 5 seconds.

An alert sound is heard and the audio guidance volume changes in the following order. Repeat step 1 until the desired volume is selected.

Medium / High / Low (Default: Medium)

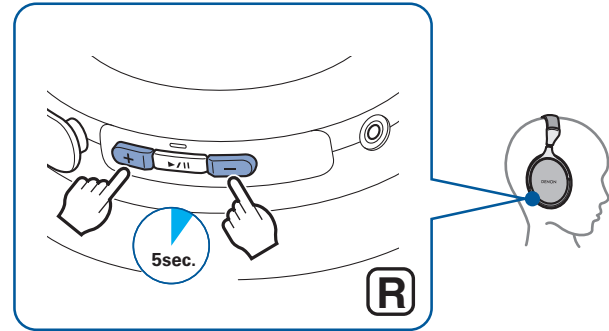

Bluetooth operation

You can enjoy listening to music wirelessly by connecting the headphones to your Bluetooth device.

Pairing

Pairing (registration) is an operation that is required in order to connect a Bluetooth device to the headphones. When using Bluetooth for the first time, you need to pair the headphones and your Bluetooth device so they can communicate with each other. Once a Bluetooth device has been paired with your headphones, pairing does not need to be performed again for future Bluetooth connections with that device.



- Pairing needs to be done again in the following cases.
 - When 9 or more devices have been paired with the headphones
These headphones can store pairing information from a maximum of 8 devices. When 9 or more devices are paired, the new pairing information overwrites the oldest pairing information in order from the oldest information onwards.
- Multiple Bluetooth devices cannot be played back at the same time.

Connecting

There are two methods for connecting with Bluetooth devices:

1

Connecting to the headphones for the first time
(👉 p. 14)

2

Reconnecting paired devices (👉 p. 16)



1: Connecting to the headphones for the first time

Check that the headphones are not connected to any Bluetooth device before pairing.

1 Turn on the Bluetooth function of your Bluetooth device.

- For details, see the Owner's Manual of the Bluetooth device that you want to connect.

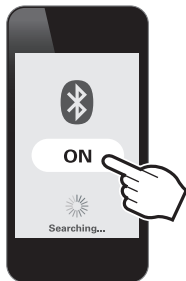

2 While the power is off, press and hold the ►/|| button for approximately 4 seconds.

The Bluetooth LED lights and then blinks in approximately 1-second intervals as the headphones enter pairing mode.

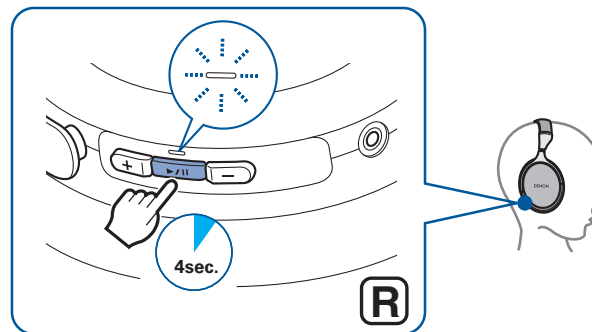

- The headphones turn on after pressing and holding the ►/|| button for approximately 2 second. Continue pressing the button.
- If the Bluetooth LED does not light even when the ►/|| button is pressed, the rechargeable battery has no power remaining. Charge the battery. (👉 p. 8)



3 Select “DENON AH-GC25W” from the list of devices displayed on the screen of your Bluetooth device.

When pairing is completed and the Bluetooth connection is established, the Bluetooth LED lights for approximately 5 seconds.

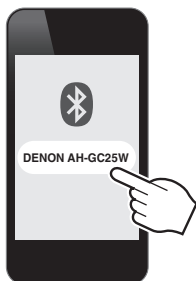

4 Playing back music on the Bluetooth device.

Music played back on the connected Bluetooth device is output from the headphones.



- If the power is on, press and hold the ►/|| button for approximately 3 seconds to turn the power off before pairing.
- The headphones pairing mode is canceled if pairing is not completed within 3 minutes. In this case, press and hold the ►/|| button for approximately 3 seconds to turn the power off and then pair the devices again.
- If you are requested to enter a PIN code (pass key), enter “0000” (four zeros).



2: Reconnecting paired devices

Check that the headphones are not connected to any Bluetooth device before connecting.

1 Turn on the Bluetooth function of your Bluetooth device.

- For details, see the Owner's Manual of the Bluetooth device that you want to connect.



2 While the power is off, press and hold the ►/|| button for approximately 2 second.

The Bluetooth LED lights for approximately 1.5 seconds and the headphones power on before automatically connecting to the Bluetooth device.

- When the Bluetooth connection is established, the Bluetooth LED lights for approximately 5 seconds.

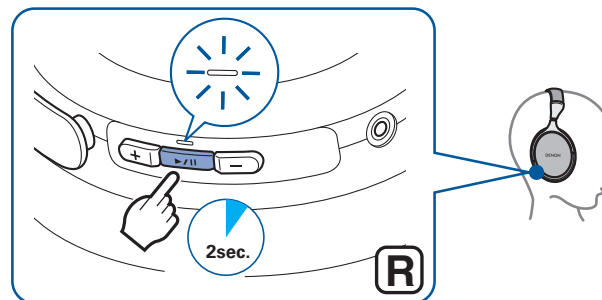

- If the Bluetooth connection is not made automatically, select "DENON AH-GC25W" from the list of devices displayed on the screen of your Bluetooth device.

3 Playing back music on the Bluetooth device.

Music played back on the connected Bluetooth device is output from the headphones.



Simultaneously connecting multiple Bluetooth devices (Multipoint function)

Two Bluetooth devices can be simultaneously connected to the headphones, but of these only one device can be used to listen to music or make phone calls at any time. It is convenient to connect devices that you use frequently so that you do not need to re-connect each time you want to switch devices.

■ Connecting to a second Bluetooth device

- 1 Turn off the Bluetooth function of the 1st paired Bluetooth device. (For details, see the Owner's Manual of the Bluetooth device that you want to connect.)**

- 2 Turn off the headphones and then pair the 2nd Bluetooth device.**

When pairing is completed and the Bluetooth connection is established, the Bluetooth LED lights for approximately 5 seconds.

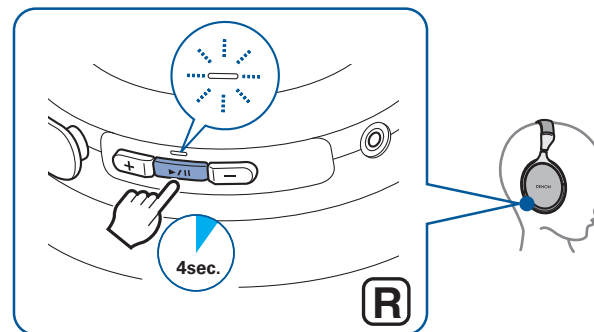

- See “1: Connecting to the headphones for the first time” (📖 p. 14) for details on how to pair devices.



- 3** Turn on the Bluetooth function of the 1st Bluetooth device, and select “DENON AH-GC25W” from the list of devices displayed on the screen.

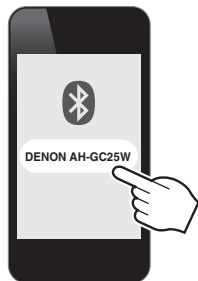

- This procedure connects two Bluetooth devices to the headphones.

■ Switching Bluetooth playback devices

- 1** Stop or pause playback on the current playback device.
- 2** Start playback on the device that you want to listen to.

■ Call standby

Simultaneous call standby is possible, but the device that receives the call first takes priority. Calls cannot be made simultaneously.



Connecting to a computer via USB

Audio data on a computer can be played through the headphones by inserting the USB cable (supplied) in the USB port of the headphones and connecting them to the computer. (👉 p. 23)

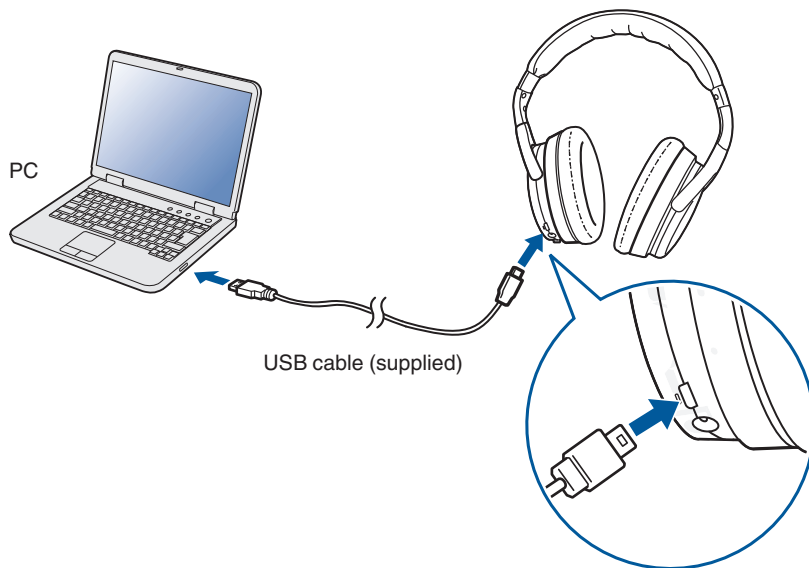

- The headphones automatically start charging when they are connected to a computer.



Listening to music

Listening to music using a Bluetooth connection

First check that the headphones and Bluetooth device are connected via Bluetooth. (👉 p. 13)

Playback operations can be performed from both the Bluetooth device and headphones. Here we will explain the operations using the buttons on the headphones.



- When the headphones are connected using the audio cable, the Bluetooth function is automatically turned off and the Bluetooth device cannot be controlled using the headphones.

Playback/pause

Press the ▶/⏸ button once.

- The Bluetooth LED flashes in 5-second intervals during playback.

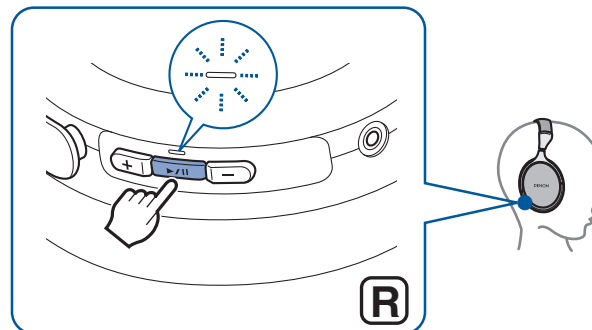

Select track

Next track: Press the ►/|| button twice.

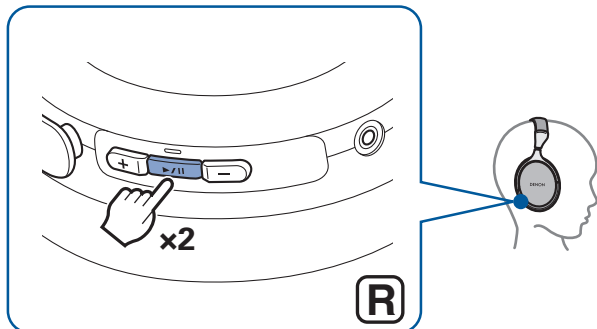

Previous track: Press the ►/|| button 3 times.

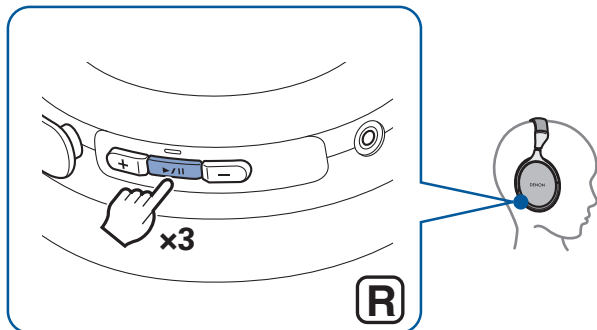

Volume adjustment

Increase volume: Press the volume "+" button.

Decrease volume: Press the volume "-" button.

- An alert sound is heard when the maximum or minimum volume is reached.

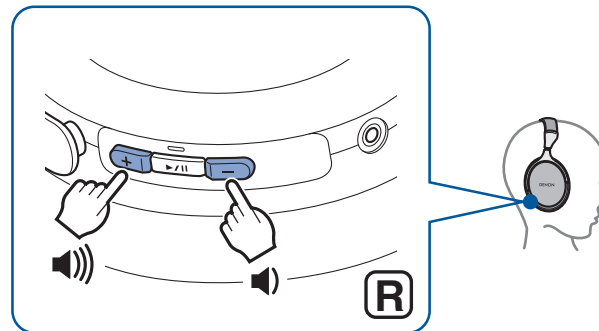

Listening to music using the audio cable

Use the included audio cable to connect to an audio device that is not equipped with Bluetooth, when Bluetooth is not allowed or the battery runs out.

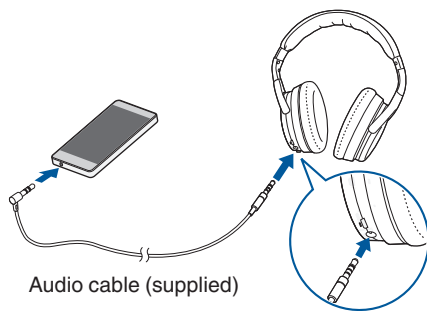

- Call and playback operations using Bluetooth are disabled when the headphones are connected via the audio cable.

Using the audio cable with remote control mic

An audio cable with a remote control mic as well as an audio cable are included with these headphones. Use the audio cable with the remote control mic to connect with remote control-compatible playback devices to play and pause music, as well as receive, make and hang up phone calls.

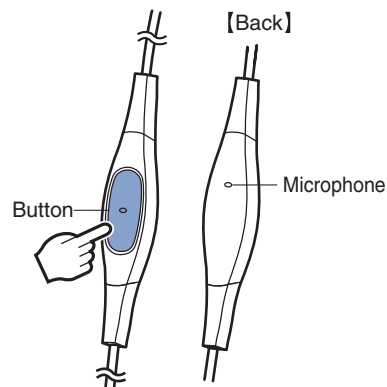

Audio playback/pause

Press the remote control button.

Answer / hang up phone call

Press the remote control button when a call is incoming or while on a call.



- Enabled remote control operations may vary depending on the device connected, and mic operations may not work correctly.



Listening to music on a computer via USB

First check that the headphones and computer are connected via USB.
( p. 19)

■ For Windows OS

- 1 Click “Start” on the computer screen and then click “Control Panel”.**

This displays the Control Panel settings list.

- 2 Click “Sound”.**

This displays the Sound menu screen.

- 3 In the “Playback” tab, make sure that “Default Device” is checked for “AH-GC25W”.**

- If it is checked for another device, select “AH-GC25W” and click “Set Default”.

- 4 Play the music in the player software on your computer.**

The music being played is output through the headphones.

■ For Mac OS

- 1 Move the cursor to “Go” on the computer screen and click “Utilities”.**

This displays the Utilities list.

- 2 Double click “Audio MIDI Setup”.**

This displays the “Audio Devices” screen.

- 3 In “AH-GC25W”, make sure that “Use this device for sound output” is checked.**

- If it is checked for another device, secondary click “AH-GC25W” and select “Use this device for sound output”.

- 4 Play the music in the player software on your computer.**

The music being played is output through the headphones.





- The buttons on the headphones can be used to control playback in addition to the controls on the computer.

Playback/pause	Press the ►/ button once
Next track	Press the ►/ button twice
Previous track	Press the ►/ button three times
Increase volume	Press the volume “+” button
Decrease volume	Press the volume “-” button

* It may not be possible to use the buttons of the headphones to control the playback with some computers or player software.



Conducting phone calls

Calls can be made while you are wearing the headphones. You can hear the caller's voice through the headphones, and your voice is picked up by the built-in microphone in the headphones. Use the call button to operate Bluetooth compatible mobile phones connected via Bluetooth.

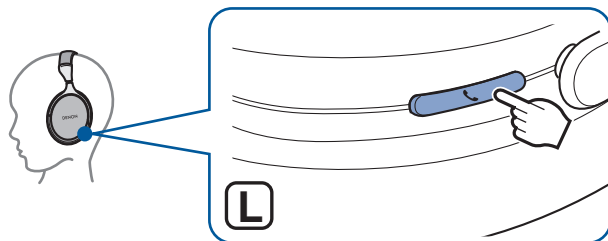

When the headphones are connected using the audio cable, the Bluetooth function is automatically turned off and calls cannot be made using the headphones.

Making a call

Dial the number with the mobile phone connected via Bluetooth. Audio playback is paused and the call is connected.

Answering an incoming call

When an incoming call is received, audio playback is paused and the ring tone is heard.

Press the call button once to answer the call.

Ending a call

Press the call button once during the call.

When a call is ended, playback of the paused track is restarted.



Using the call waiting function

If you receive a call while another call is already in progress, you can place the current call (call A) on hold and switch to the new call (call B).



- Some of mobile phones may not be compatible with these functions.

1 Press the call button once during the call.

- This places the current call (call A) on hold and switches to the new call (call B).
- When the new call (call B) ends, the headphones return to the call that is on hold (call A).

■ To return to the call that is on hold (call A)

1 Press and hold the call button for approximately 3 seconds during the call (call B).

- This places the current call (call B) on hold and switches to the call that is on hold (call A).

Ignoring an incoming call

Press and hold the call button for approximately 3 seconds when an incoming call is received.

Switching a call from the headphones to a mobile phone

Switch the current call to the mobile phone.
Press the call button three times.



- The switch operation cannot be used when a call waiting call is received. Switch using the mobile phone.



Other operations

Incoming call detected	Answer	Press the call button once
In standby mode/ During audio playback	Voice dial/ Voice activated call	Press and hold the call button
Call in progress	End call	Press the call button once
	Mute on/off	Press the call button twice



- Press the volume buttons (+/-) to adjust the volume of the caller's voice.

Turning the power off

1 Press and hold the ►/|| button for approximately 3 seconds.

The Bluetooth LED turns off and the power is turned off.

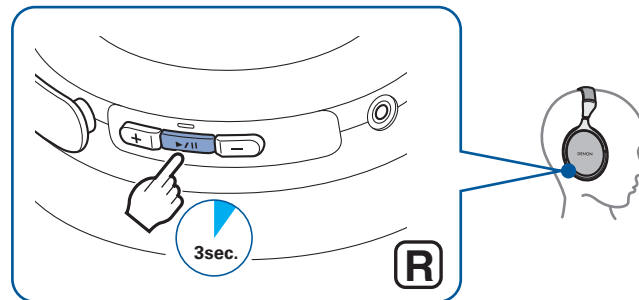

- A small amount of power is consumed even when the power is off.



Information

Audio Playback and Phone Calls on a Bluetooth Device

- These headphones are compatible with SCMS-T content security standards. You can use these headphones with SCMS-T compatible mobile phones or devices.
 - In order to listen to music via a Bluetooth connection, the connected Bluetooth device needs to be A2DP (Advanced Audio Distribution Profile) compatible. (*)
 - In order to control playback of the Bluetooth device using the headphones, the connected Bluetooth device needs to be AVRCP (Audio Video Remote Control Profile) compatible. (*)
 - The connected Bluetooth device needs to be compatible with either HSP (Headset Profile) or HFP (Hands-free Profile) in order to use the headphones for conducting phone calls. (*)
 - The Bluetooth device needs to be compatible with either HFP or HSP and A2DP in order to conduct calls during audio playback. (*)
- * For details on profiles that the Bluetooth device is compatible with, see the Bluetooth device Owner's Manual.

Deleting pairing information

Delete pairing information if you have made a mistake entering pairing information or when re-pairing a device.

1 Press and hold the volume “+” button for approximately 5 seconds while in pairing mode.

The Bluetooth LED flashes 5 times and the pairing information is erased.

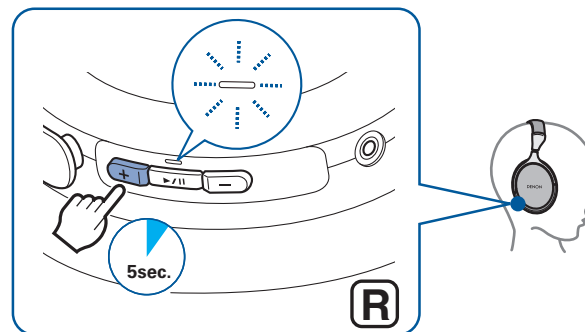

- To make a Bluetooth connection after clearing the pairing information, follow the instructions on “1: Connecting to the headphones for the first time” (📖 p. 14).



Troubleshooting

First, check the following.

1. Are all of the connections correct?
2. Were the instructions in the manual followed correctly?
3. Is the connected device being operated correctly?

If the headphones do not operate properly, check the corresponding issue here.

If the issue is not covered here, there may be a malfunction. Contact the store where you purchased the headphones. If the staff at the store where you purchased the headphones also do not know how to resolve the issue, contact the Denon Customer Service Center or your nearest Repairs Center.

Power does not turn on / power is turning off automatically

Power does not turn on.

- When the rechargeable battery has no power remaining, connect the headphones to an AC adapter or computer using the supplied USB cable to charge the battery. (👉 p. 8)

The device cannot be charged

The headphones cannot be charged.

- Check whether the power plug is correctly inserted into the power outlet. (👉 p. 8)
- Make sure the supplied USB cable is inserted correctly into the headphones. (👉 p. 8)
- If the headphones are connected to the computer via the USB port, check that the computer is powered on.



No sound comes out

No sound comes out.

- Check that the headphones and the connected device are powered on.
- Adjust the volume of the headphones and the connected device to a suitable level. (👉 p. 21)
- Pair the headphones with the Bluetooth device. (👉 p. 14)
- If you are trying to play music on a computer via USB, check that the supplied USB cable is fully connected. (👉 p. 19)

Sound is distorted, noisy, or cuts in and out

Sound is distorted, noisy, or cuts in and out.

- Adjust the volume of the headphones and the connected device to a suitable level. (👉 p. 21)
- The Bluetooth device is out of range. Bring the Bluetooth device closer to the headphones.
- The Bluetooth connection is experiencing wireless interference. Move the headphones away from appliances such as microwave ovens and other wireless devices.
- Power cycle the device and try again.



Cannot play media using Bluetooth

Cannot connect using Bluetooth.

- Check that the power of the Bluetooth device is on and the Bluetooth function is enabled.
- Check whether the Bluetooth device is in sleep status.
- Bring the headphones and the Bluetooth device closer together.
- Turn the Bluetooth device off and back on and try again.
- Pair the devices again. (👉 p. 14)
- Select A2DP as the Bluetooth connection profile on the transmitting Bluetooth device. For details, see the Owner's Manual of the Bluetooth device.
- If the USB cable is connected, remove it.
- If the audio cable is connected, remove it.

Sound is not output from the headphones when connected using Bluetooth.

- Check that audio is being played back on the Bluetooth device.
- Increase the volume. Increase the volume on the Bluetooth device if it is necessary to adjust the volume on the Bluetooth device. (👉 p. 21)



Cannot make a phone call

Cannot make a phone call.

- Some smartphones and phone apps do not support hands-free calls.

Cannot hear the caller's voice.

- Press the call button to switch to the call if it comes while you are listening to music on the headphones. (👉 p. 25)
- Check that the power of the Bluetooth device is on and the Bluetooth function is enabled.
- Select HSP or HFP as the Bluetooth connection profile on the transmitting Bluetooth device. For details, see the Owner's Manual of the Bluetooth device.
- Check that the Bluetooth device is set to handle calls through the headphones. For details, see the Owner's Manual of the Bluetooth device.
- Increase the incoming call volume. (👉 p. 27)



Precautions for Use

- Be sure to read the Owner's Manual of the device that you want to connect.
- Check the volume settings when using the headphones on public transport or in public places and make sure you do not disturb people around you.
- These headphones are not guaranteed to work with all combinations of Bluetooth devices/mobile phones.
- These headphones do not support connection with all Bluetooth devices/mobile phones.
- Bluetooth wireless technology can communicate over a distance of approximately 10 m. However, obstructions (people, metallic objects, walls, etc.) and radio wave conditions affect the range in which communication is possible.
- The Bluetooth device that you want to connect must support the same profile as these headphones in order to use the Bluetooth function. For details on profiles that the Bluetooth device is compatible with, see the Bluetooth device Owner's Manual.
- Due to features of Bluetooth wireless technology, playback of audio on the headphones is slightly delayed compared to the voice/audio playback on the transmitting device.



Disposal of these headphones

The rechargeable battery built into these headphones can be recycled. Contact the Denon Customer Service Center for details on disposing of these headphones.

Trademark information



The Bluetooth® word mark and logos are registered trademarks owned by the Bluetooth SIG, Inc. and any use of such marks by D&M Holdings Inc. is under license. Other trademarks and trade names are those of their respective owners.



Qualcomm aptX and Qualcomm cVc are products of Qualcomm Technologies, Inc. and/or its subsidiaries. Qualcomm is a trademark of Qualcomm Incorporated, registered in the United States and other countries. aptX and cVc are trademarks of Qualcomm Technologies International, Ltd., registered in the United States and other countries.



Specifications

■ Headphone section

Type:	Dynamic type
Drive units:	φ40 mm
Impedance:	24 Ω/ohms
Sound pressure sensitivity:	98 dB/mW
Maximum input:	1,000 mW
Playback frequency:	5 – 40,000 Hz

■ Bluetooth section

Compatible standards:	Bluetooth Ver. 5.0
Transmission power class:	Max. transmission power 10 mW (Class 1)
Compatible profiles:	A2DP/AVRCP/HSP/HFP
A2DP codec support:	aptX HD/aptX/AAC/SBC
Continuous playback time:	Approx. 30 hours



■ USB audio component

Supported format:

PCM 16-bit / Sampling frequencies: 48, 44.1, 32 kHz

Supported device class:

Audio device class ver.1.0, HID class ver.1.11

■ General

Operating temperature range:

5 °C - 40 °C

Power supply:

DC 3.7 V (internal lithium polymer rechargeable battery)

Weight:

283 g

* For purposes of improvement, specifications and design are subject to change without notice.



DENON[®]

www.denon.com

3520 10658 00ADA

Copyright © 2019 D&M Holdings Inc. All Rights Reserved.