

DENON[®]

DCD-2500NE

SUPER AUDIO CD PLAYER

Owner's Manual

You can print more than one page of a PDF onto a single sheet of paper.

[Front panel](#)[Display](#)[Rear panel](#)[Remote](#)[Index](#)

Accessories	4
Inserting the batteries	5
Operating range of the remote control unit	5
Features	6
High quality sound	6
High performance	7
Part names and functions	8
Front panel	8
Display	10
Rear panel	11
Remote control unit	12

Connections

Connecting to a stereo audio amplifier	17
Connecting to a device with digital audio input connectors	18
Connecting the timer device	19
Connecting the power cord	20

Playback

Basic operation	22
Turning the power on	22
Switching the display's brightness	23
Switching the Pure Direct mode	23
Setting the top priority playback layer for Super Audio CDs	24
Playing CDs/Super Audio CDs	25
Playing CDs and Super Audio CDs	25
Playing tracks in a specific order (Program playback)	27
Playing Data CDs and Data DVDs	29
Playing files	30
Using the timer play function	32



Settings

Setting the Auto Standby mode	33
Turning Auto Standby mode off	33
Turning Auto Standby mode on	33

Tips

Tips	35
Troubleshooting	36

Appendix



Playable media	40
Discs	40
Playback order of music files	42
About discs and files	43
Cautions on using media	44
Inserting a disc	44
How to handle media	45
Cleaning discs	45
Explanation of terms	46
Trademark information	49
Specifications	50
Index	53



Thank you for purchasing this Denon product. To ensure proper operation, please read this owner's manual carefully before using the product. After reading this manual, be sure to keep it for future reference.

Accessories

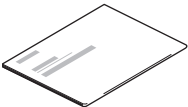
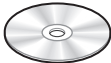
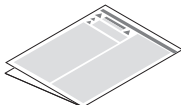
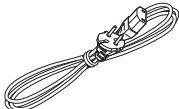
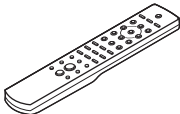
Check that the following parts are supplied with the product.

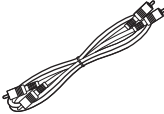
 Quick Start Guide	 CD-ROM (Owner's Manual)	 Safety Instructions	 Power cord
 Remote control unit (RC-1207)	 R03/AAA batteries	 Audio cable	



Inserting the batteries

- 1 Remove the rear lid in the direction of the arrow and remove it.

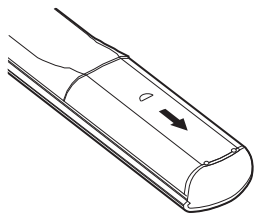

- 2 Insert two batteries correctly into the battery compartment as indicated.

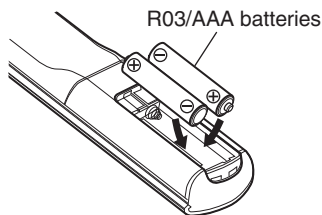

- 3 Put the rear cover back on.

NOTE

- When inserting the batteries, be sure to do so in the proper direction, following the ⊕ and ⊖ marks in the battery compartment.
- To prevent damage or leakage of battery fluid:
 - Do not use a new battery together with an old one.
 - Do not use two different types of batteries.
- Remove the batteries from the remote control unit if it will not be in use for long periods.
- If the battery fluid should leak, carefully wipe the fluid off the inside of the battery compartment and insert new batteries.

Operating range of the remote control unit

Point the remote control unit at the remote sensor when operating it.

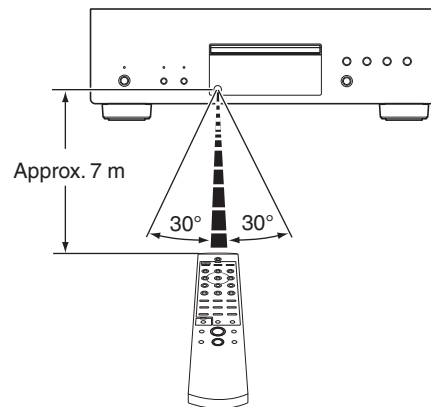

Features

High quality sound

- **High Bitrate and High Sampling with Advanced AL32 Processing Plus**

A high bitrate and high sampling has been achieved with Denon's unique data interpolation algorithm. 16 bit audio signals are converted to a high bitrate of 32 bit and 44.1 kHz sampling signals are up-sampled by 16x to achieve smoother recreation of sound waves. Data interpolation is also used, predicting interpolation points from a large number of surrounding points to provide audio as close as possible to the original sound. This elaborate restoration of data lost during digital recording achieves fine, distortion-free rendering, accurate sound localizing, rich bass and recreation that is faithful to the original sound.

- **DAC Master Clock Design for the Ideal Clock**

To make full use of the properties of this unit's semiconductor, it was important to use a highly accurate clock signal for the semiconductor's operations. This model contains 2 new oscillators, one for each frequency. These oscillators are developed to dramatically decrease phase noise caused by frequency displacement, achieving a more stable and more accurate clock than ever before. The master clock is near the D/A converter, reducing jittering to achieve faithful playback.

- **Advanced S.V.H. Mechanism & Direct Mechanical Ground Construction**

Each part of the newly developed Advanced S.V.H. Mechanism is made from a different material to suit its purpose, including an aluminum die cast tray. The high weight of these parts improves damping, and the resonance points are also decentralized to provide a high level of damping. The center of gravity of the mechanical parts has been lowered. In addition to reducing internal vibration caused by the rotation of the disc, this also makes the structure resistant to external vibration. A Direct Mechanical Ground construction is also used. Through measures such as placing the power transformer near the feet, this construction thoroughly removes the effects of internal and external vibration and thoroughly prevents transmission of unnecessary vibration and emission of noise.



High performance

- **Supports high-resolution audio sources stored on discs**
MP3, WMA, AAC, WAV, FLAC, ALAC, AIFF and DSD files that have been recorded onto DVD-R/-RW/+R/+RW or CD-R/-RW discs can be played back on this CD player.
- **Reduced power consumption during standby**
In consideration of the environment, power consumption during standby has been reduced to 0.1 Watts or better.



Part names and functions

Front panel

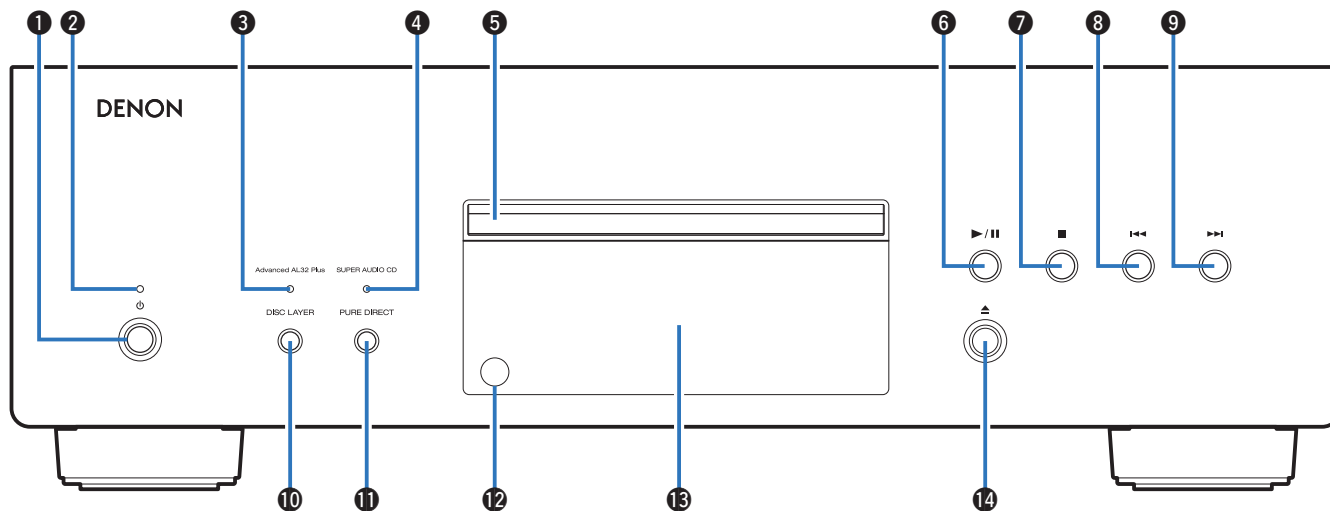

1 Power operation button (b)

Turns power to this unit on and off. (📖 p. 22)

2 Power indicator

This is lit as follows according to the power status:

- Power on : Green
- Standby : Off
- Power off : Off



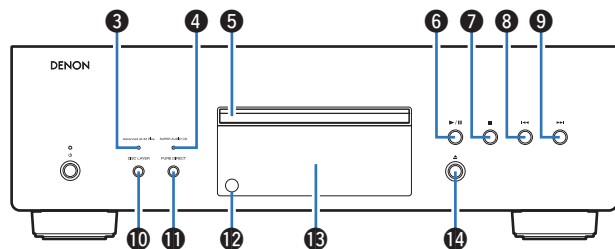

3 Advanced AL32 Plus indicator

When this unit is used in the following ways, Advanced AL32 Processing Plus is activated and this light turns on.

- When a CD is inserted
- When a data disc is inserted
- When "CD" is set as the layer mode of a Super Audio CD



- When a DSD file is played, Advanced AL32 Processing Plus stops and this light turns off.

4 SUPER AUDIO CD indicator

This light turns on when this unit is used in the following ways.

- When a Super Audio CD is inserted
- When "STEREO" or "MULTI" is set as the layer mode of a Super Audio CD

5 Disc tray

Used to insert a disc.

6 Play/pause button (▶ / ||)

Plays the track/Pauses the track.

7 Stop button (■)

Stops playback.

8 Reverse-skip button (◀◀)

Returns to the start of the currently playing track.

9 Forward-skip button (▶▶)

Plays the next track.

10 DISC LAYER button

This switches the Super Audio CD layer. (🔗 p. 24)

11 PURE DIRECT button

This switches the Pure Direct mode. (🔗 p. 23)

12 Remote control sensor

This receives signals from the remote control unit. (🔗 p. 5)

13 Display

This displays various pieces of information. (🔗 p. 10)

14 Disc tray open/close button (▲)

Opens and closes the disc tray.



Display

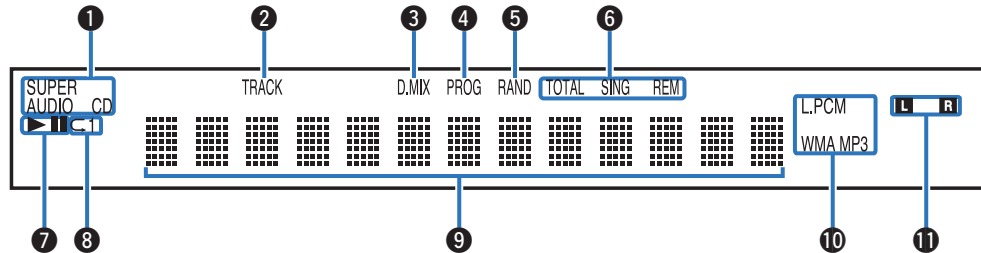

1 Disc media indicators

Displays the type of disc that is being played back.

2 Track number indicator

Lights up when displaying the track number.

3 Downmix indicator (D.MIX)

This light turns on when a multi-channel area of a Super Audio CD is played.

4 Program indicator (PROG)

Lights up during program playback.

5 Random indicator (RAND)

Lights during random playback.

6 Time display indicators

TOTAL REM : Lights up when displaying the remaining time in all-track playback.

SING REM : Lights up when displaying the remaining time in singletrack playback.

7 Playback mode indicators

▶ : Lights up during playback.

|| : Lights up during pause.

8 Repeat mode indicator

Lights to match the repeat mode settings.

9 Information display

Displays various information or playback elapsed time and so on of the disc.

10 Playback format indicators

Lights up while an WAV/MP3/WMA file is being played back.

11 Playback signal channel indicator

The respective indicator will light corresponding to the output signal.

L : Front left

R : Front right



Rear panel

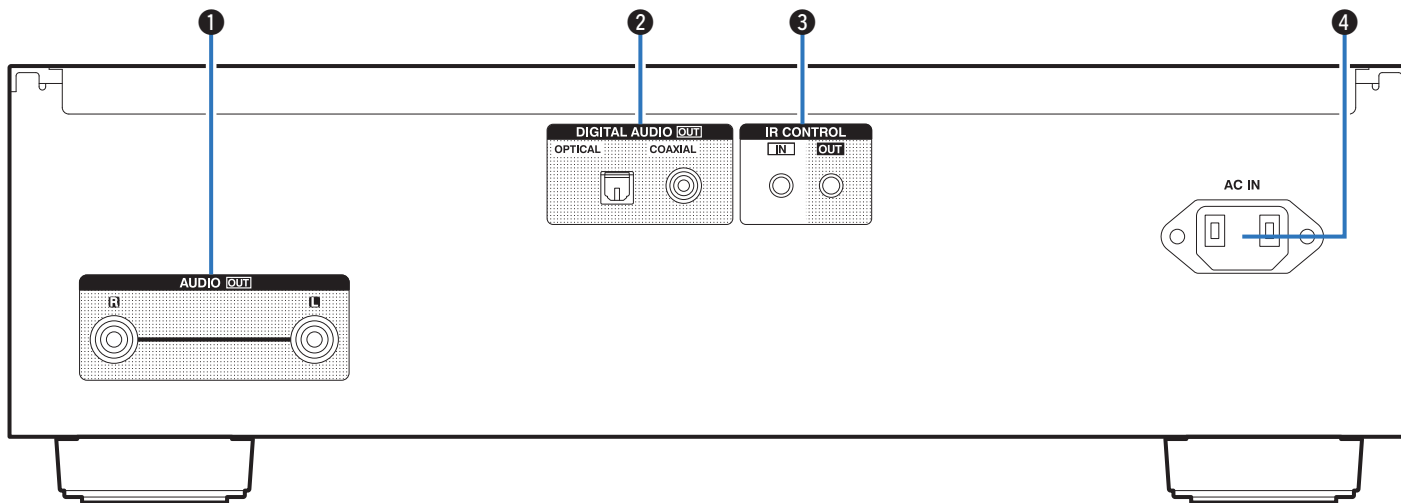

1 AUDIO OUT connectors

Used to connect devices equipped with analog audio inputs connectors or an external amplifier. (🔗 p. 17)

2 DIGITAL AUDIO OUT connectors (OPTICAL/COAXIAL)

Used to connect an AV receiver or D/A converter that has a digital input connectors. (🔗 p. 18)

3 IR CONTROL jacks

Used to connect Denon network audio players with an IR controller.

4 AC inlet (AC IN)

Used to connect the power cord. (🔗 p. 20)



Remote control unit

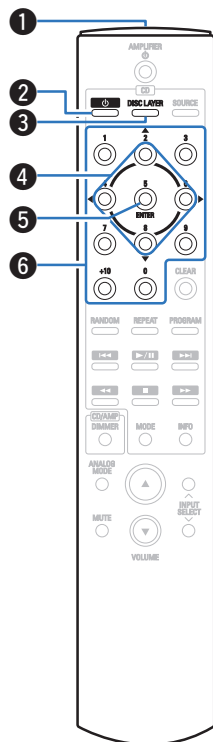

■ Operating this unit

- 1 Remote control signal transmitter**
 This transmits signals from the remote control unit. (☞ p. 5)
- 2 Power operation button (⏻)**
 This turns the power on/off (standby). (☞ p. 22)
- 3 DISC LAYER button**
 This switches the playback layer of a Super Audio CD.
 - “Setting the top priority playback layer for Super Audio CDs” (☞ p. 24)
 - “Playing CDs and Super Audio CDs” (☞ p. 25)
- 4 Cursor buttons (⬆️⬇️⬇️⬆️)**
 These select items.
- 5 ENTER button**
 This determines the selection.
- 6 Number buttons (0 – 9, +10)**
 These enter numbers into the unit.

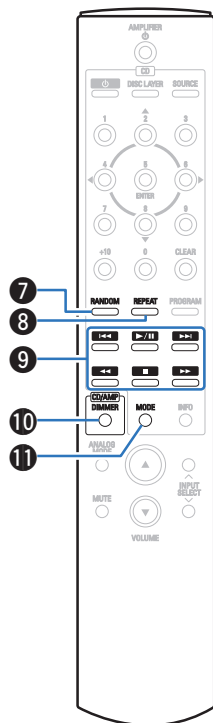
**7 RANDOM button**

Switches the random playback.

8 REPEAT button

Switches the repeat playback.

9 System buttons

These perform playback related operations.

- Skip buttons (⏮ / ⏭)
- Play/pause button (▶/⏸)
- Fast-reverse/Fast-forward buttons (⏪ / ⏩)
- Stop button (■)

10 DIMMER button

This switches the brightness of the display. (🔧 p. 23)

11 MODE button

This switches the playback mode. (🔧 p. 31)



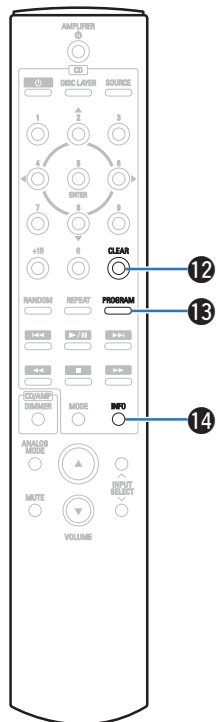

12 CLEAR button

This clears the program registration. (🔗 p. 28)

13 PROGRAM button

This sets program playback. (🔗 p. 27)

14 Information button (INFO)

This switches the track information shown in the display during playback.



- You cannot use the SOURCE button for the operation of this unit.



■ Amplifier operations

A Denon amplifier can be operated.

- ① Power operation button (AMPLIFIER ϕ)
- ② DIMMER button
- ③ ANALOG MODE button
- ④ MUTE button
- ⑤ VOLUME buttons (\blacktriangle \blacktriangledown)
- ⑥ Input source select buttons (INPUT SELECT)

NOTE

- The remote control may not operate some products.

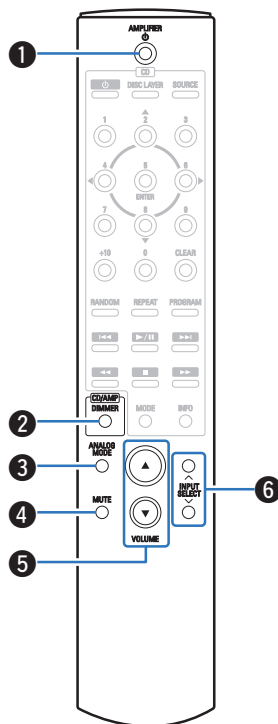

■ Contents

Connecting to a stereo audio amplifier	17
Connecting to a device with digital audio input connectors	18
Connecting the timer device	19
Connecting the power cord	20

NOTE

- Do not plug in the power cord until all connections have been completed.
- Do not bundle power cords together with connection cables. Doing so can result in noise.

■ Cables used for connections

Provide necessary cables according to the devices you want to connect.

Audio cable
(supplied)



Optical cable
(Sold separately)



Coaxial digital cable
(Sold separately)



Connecting to a stereo audio amplifier

Use this connection for audio playback via an amplifier.

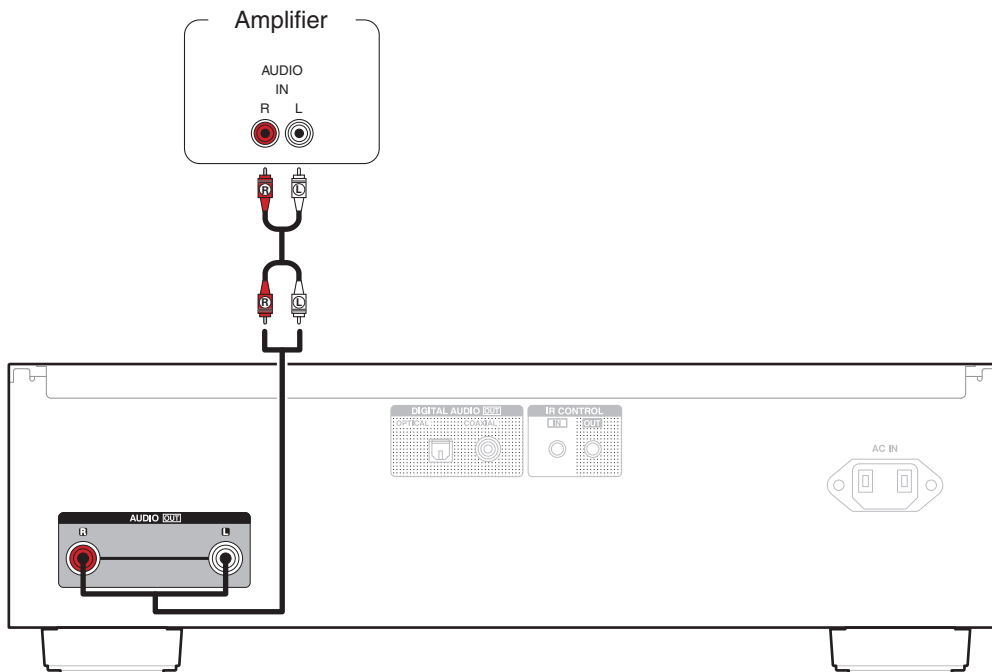

Connecting to a device with digital audio input connectors

You can enjoy digital audio playback by connecting an AV receiver or D/A converter that has a digital audio connector to this unit.

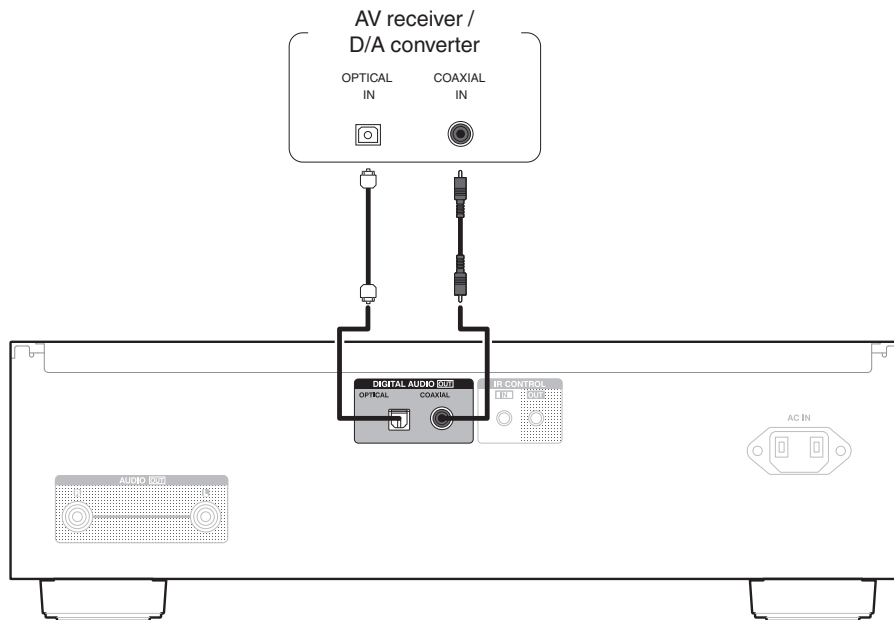

NOTE

- Digital audio output stops during playback of the HD layer of Super Audio CDs, DSD files and files with a sampling frequency of 32 kHz.



Connecting the timer device

This unit can perform timer play when an amplifier and timer device are connected to this unit. (“Using the timer play function” (🔗 p. 32))

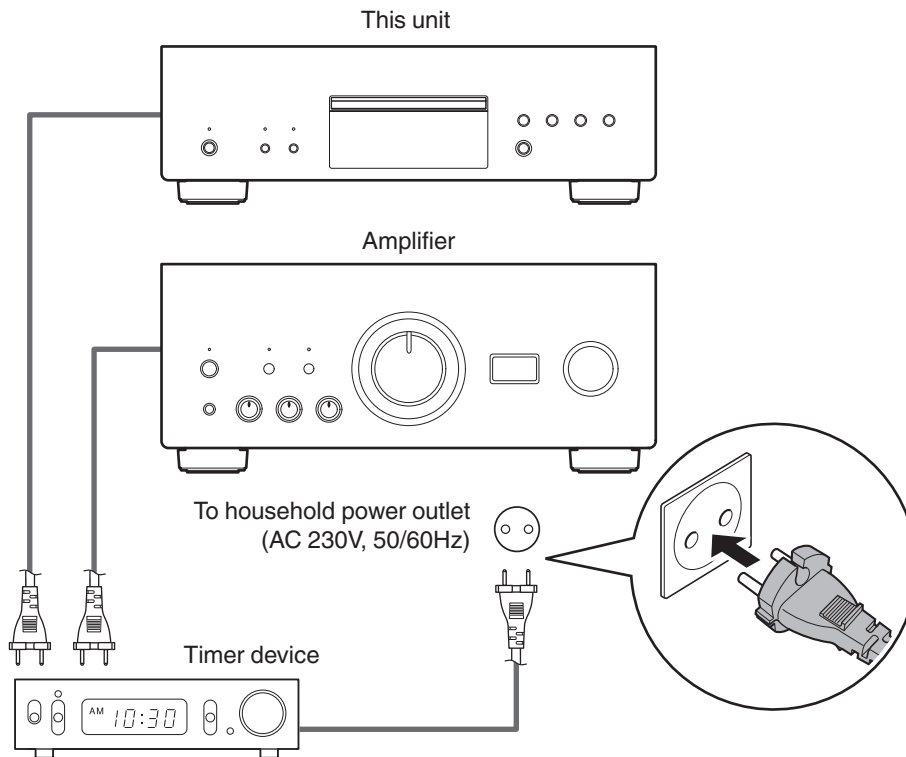

Connecting the power cord

After completing all the connections, insert the power plug into the power outlet.

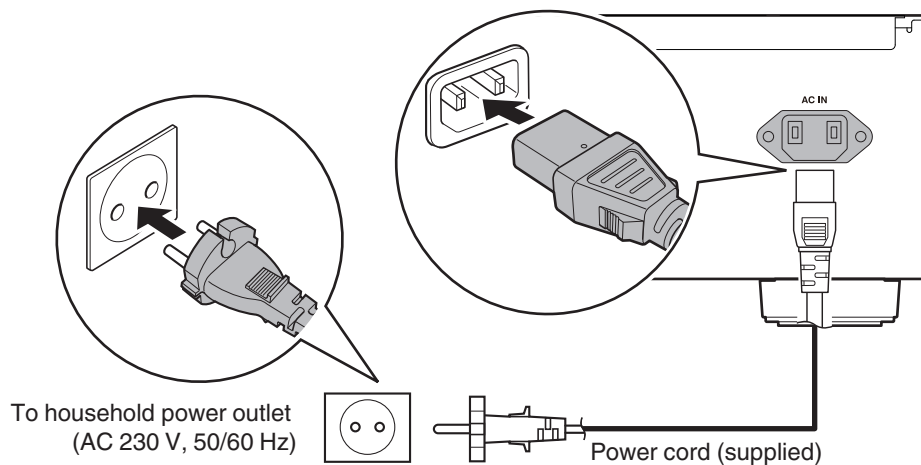

■ Contents

Basic operation	22
Playing CDs/Super Audio CDs	25
Playing Data CDs and Data DVDs	29
Using the timer play function	32



Basic operation

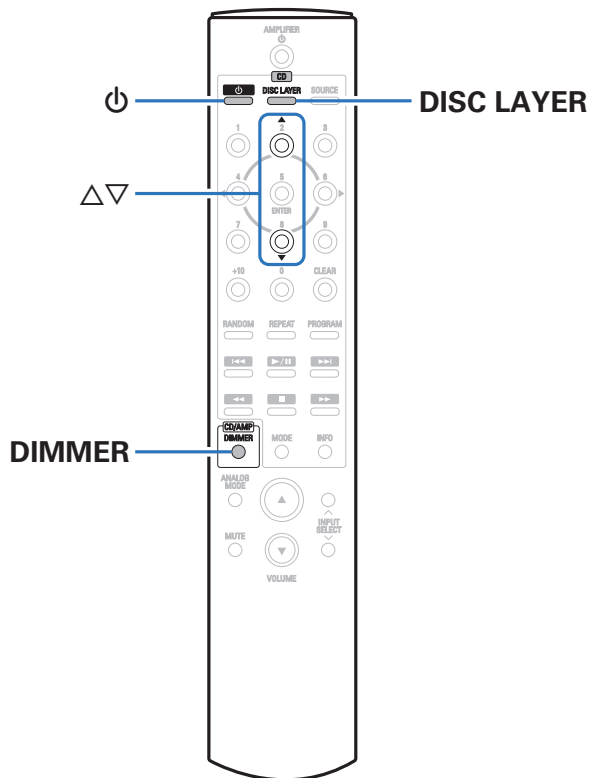

Turning the power on

- 1 Press  on this unit to turn the power on.
The power indicator lights green.



- Press  on the remote control unit to turn on power from standby mode.

■ When power is switched to standby

- 1 Press  on the remote control unit.

NOTE

- Power continues to be supplied to some of the circuitry even when the power is in the standby mode. When leaving home for long periods of time or when going on vacation, either press  on the main unit to turn off the power, or unplug the power cord from the power outlet.



Switching the display's brightness

The brightness of the display can be adjusted to one of four levels.

1 Press DIMMER.



- The DIMMER button also controls the Denon's Integrated Amplifier PMA-2500NE, so the PMA-2500NE can be operated simultaneously with this unit.

■ Dimmer setting menu

When the Denon PMA-2500NE integrated amplifier is used with this unit, you can set different brightnesses for this unit and the PMA-2500NE by calling the Dimmer setting menu separately.

1 Press and hold DIMMER for more than 2 seconds.

The dimmer setting menu appears on the display.

2 Use Δ / ∇ to change to desired setting.

Bright (Default) :	Normal display brightness.
Dim :	Reduced display brightness.
Dark :	Very low display brightness.
Off :	Turns the display off.

Switching the Pure Direct mode

When the Pure Direct mode is used, the display turns off and digital output stops.

This reduces the source of noise that can adversely affect sound quality, enabling high quality playback.

1 Press PURE DIRECT on this unit.

The display turned off, and Pure Direct playback begins.

- To turn off this mode, press PURE DIRECT again.

NOTE

- In the Pure Direct mode, DIMMER is not available for operation.
- The display is only turned off during playback.



Setting the top priority playback layer for Super Audio CDs

The layer that is played with priority when the disc is loaded can be set.

1 Check that no disc is loaded.

- If the layer is switched while the disc is being loaded, the playback layer switches for that disc, but the top priority playback layer setting itself does not change.

2 Press DISC LAYER and switch to the layer you want to set.

STEREO (Default):	Plays back the 2-channel area of the Super Audio CD.
MULTI:	Plays back the multi-channel area of the Super Audio CD. The analog output of this unit outputs a down-mixed 2-channel signal.
CD:	Plays back the CD layer of the Super Audio CD.



- The layer for playback can also be switched by pressing DISC LAYER on this unit.
- When a disc is loaded after the setting has been made, the contents recorded on the set layer are displayed.
- If a disc that does not contain the layer set for top priority playback is loaded, the contents recorded on another layer are displayed automatically.
- This setting is stored in the memory and is not cleared even when the disc holder is opened or closed or the power is turned off. To change the setting, repeat the procedure above.
- The priority playback layer cannot be set when a disc is inserted or "Open" is shown on the display.
- If the area and layer have not been set for a disc, the priority playback order is as follows:
 - ① STEREO
 - ② MULTI
 - ③ CD



Playing CDs/Super Audio CDs

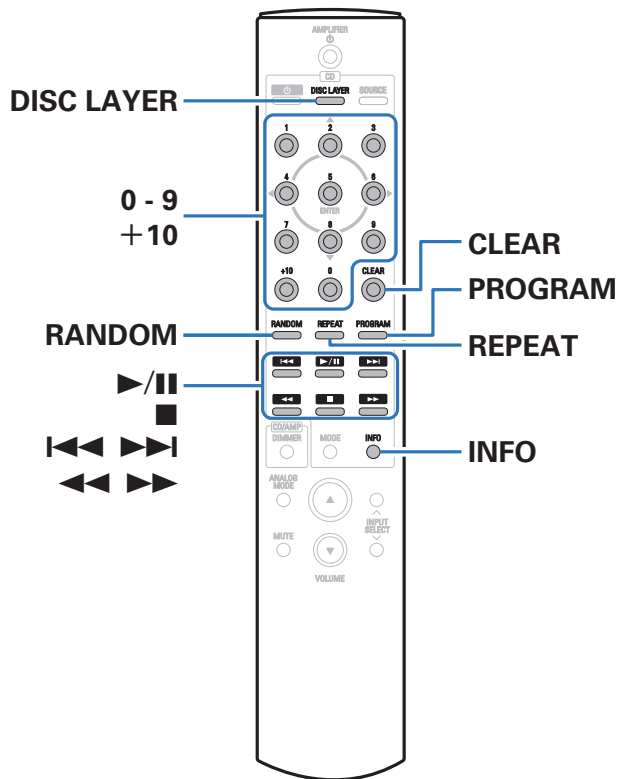

Playing CDs and Super Audio CDs

- 1 Insert a disc.** (👉 p. 44)
 - Press **▶** on the unit to open/close the disc tray.
- 2 When playing back a Super Audio CD, press DISC LAYER to set the playback layer.** (👉 p. 24)
- 3 Press ▶/||.**

The ▶ indicator lights on the display.
Playback starts.

NOTE

- Do not place any foreign objects in the disc tray. Doing so could damage the unit.
- Do not push the disc tray in by hand when the power is turned off. Doing so could damage the unit.



Operation buttons	Function
	Playback / Pause
	Stop
	Skip to previous track / Skip to next track
	Fast-reverse / Fast-forward
0 - 9, +10	Select the track
RANDOM	Random playback
REPEAT	Repeat playback
	<ul style="list-style-type: none"> Switching between All-track repeat and Single-track repeat.
INFO	Time display switching
	<ul style="list-style-type: none"> Switching between elapsed time of the current track, remaining time of the current track and remaining time of all tracks. The time displayed on this unit may differ from this actual time, as it is calculated by truncating to the nearest 1 second.
	Text information recorded on the Super Audio CD appears in the display.

■ Switching the display

Press INFO.

Displays text and time information stored on media.

- The text information is only displayed for Super Audio CD.
- The player can display the following characters :

ABCDEFGHIJKLMNOPQRSTUVWXYZ

abcdefghijklmnopqrstuvwxyz

0123456789

!"#\$%&:;<>?@\[_`!{}~^'()*+,-./=(space)

■ Discs that can be played back

- See "Discs". (👉 p. 40)



■ Playing a specific track (Direct searching)

1 Use 0 – 9 and +10 to select the tracks.

[Example]

Track 4 :

Press number 4 to select track 4.

Track 12 :

Press numbers +10 and 2 consecutively to select track 12.

Playing tracks in a specific order (Program playback)

Up to 20 tracks can be programmed.

1 In the stop mode, press PROGRAM.

The program indicator lights on the display.

2 Use 0 – 9 and +10 to select the tracks you want to program.

[Example]

To program tracks 3 and 12 to be played in that order, press 3, +10 and 2 one after the other.

3 Press ►/II.

Playback starts in the programmed order.



- When REPEAT is pressed during program playback, the tracks are played repeatedly in the programmed order.



■ Checking the order of the programmed tracks

In the stop mode, press ►►I.

The track numbers are displayed in the programmed order each time the button is pressed.

■ To clear the last track programmed

In the stop mode, press CLEAR.

The last track programmed is cleared each time the button is pressed.

■ Clearing the all programmed track

In the stop mode, press PROGRAM.



Playing Data CDs and Data DVDs

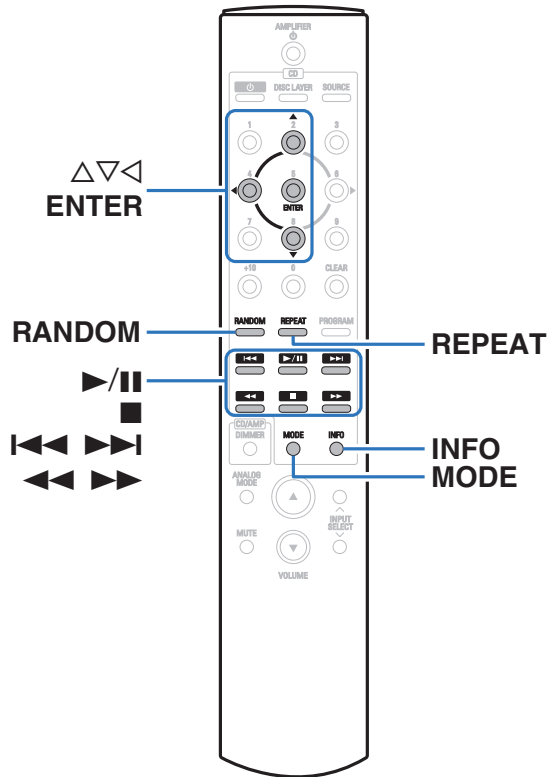

- This section explains how to playback music files that are recorded onto a CD-R/-RW or DVD-R/-RW/+R/+RW.
- There are many music distribution sites on the Internet allowing you to download music files in MP3 or WMA (Windows Media® Audio) format. The music (files) downloaded from such sites can be stored on CD-R/-RW or DVD-R/-RW/+R/+RW discs and played on this unit.
- The audio format types and specifications supported by this unit for playback are as follows.
See “Playable files” for details. (👉 p. 41)





- MP3
- WMA
- AAC
- WAV
- FLAC
- ALAC
- AIFF
- DSD

“Windows Media” and “Windows” are the trademarks or registered trademarks of Microsoft Corporation in the United States and other countries.



Playing files

- 1 Load a CD-R/-RW or DVD-R/-RW/+R/+RW disc containing music files into the disc tray. (🔗 p. 44)
 - Press  on the unit to open/close the disc tray.
- 2 Use $\Delta \nabla \triangleleft$ to select the folder to be played, then press ENTER.
- 3 Use $\Delta \nabla$ to select the file to be played, then press ENTER.
Playback starts.

Operation buttons	Function
	Playback / Pause
	Stop
	Skip to previous track / Skip to next track
	Fast-reverse / Fast-forward
	Moving up a level in the folder tree
$\Delta \nabla$	Select the item
ENTER	Enter the selected item / Playback
MODE	Select the playback range
RANDOM	Random playback
REPEAT	Repeat playback <ul style="list-style-type: none"> • Switching between All-track repeat and Single-track repeat.
INFO	Switch the display between the elapsed playback time, text information stored in the file and the file format.



- To play another file while playing from a CD-R/-RW or DVD-R/-RW/+R/+RW, press \triangleleft to display the folder tree, $\Delta \nabla$ to select the file to be played, and then press ENTER.



■ Switching the display

During playback, press INFO.

- Switch the display between the elapsed playback time, text information stored in the file and the file format.
- If a file does not support text information or no track information is recorded, the file name is displayed.
- The player can display the following characters:

ABCDEFGHIJKLMNOPQRSTUVWXYZ

abcdefghijklmnopqrstuvwxyz

0123456789

!"#\$%&:;<>?@\[_`!{~^'()*+,-./=(space)

- The folder and file numbers are set automatically when the disc is loaded.

NOTE

- Copyright-protected files cannot be played.
Note that depending on the software used for burning and other conditions, some files may not play or display correctly.

■ Files that can be played back

- See "Playable files". (📖 p. 41)

■ Switching the playback range

In the stop mode, press MODE.

- The playback range of a track can be set.

Folder mode:

All the files in the selected folder are played.

All mode:

All the files in the disc are played.



- The folder hierarchy is not displayed when "All mode" is set as the playback range.



Using the timer play function

- 1 Turn on the power of the connected components.** (👉 p. 19)
- 2 Switch the amplifier's function to input from the connected unit.**
- 3 Load a disc.**
- 4 Set the audio timer for the desired times.**
 - Refer also to the owner's manual of the audio timer.
- 5 Turn the timer "On".**
 - The power of the components connected to the timer turns off.
 - When the set time is reached, the power of the different components automatically turns on and playback starts from the first track.

NOTE

- The timer play does not support the random play or program play.



Setting the Auto Standby mode

When Auto Standby mode is set to On, if the unit remains in the stopped state and no operations are performed or if there are no input signals for approximately 30 minutes, the unit automatically switches to standby mode.

The default setting is "On".

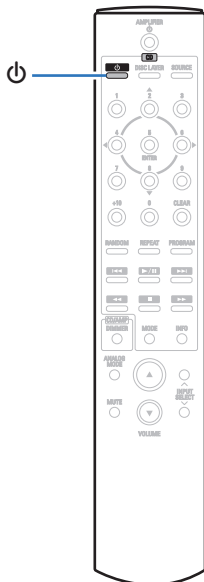

Turning Auto Standby mode off

- 1 Press and hold  for more than 5 seconds to turn the Auto Standby mode off.

The power indicator flashes once.

Turning Auto Standby mode on

- 1 Press and hold  for more than 5 seconds to turn the auto standby mode on.

The power indicator flashes three times.



■ Contents

Tips

I want to enjoy analog output audio at higher quality	35
I want to playback just the specified folder	35
I want to display Super Audio CD text	35
I want to play the multi-channel area of a Super Audio CD is played	35
I want to play all tracks on a DVD-R/-RW/+R/+RW or CD-R/-RW at random	35

Troubleshooting

Power does not turn on / Power is turned off	36
Operations cannot be performed through the remote control unit	37
Display on this unit shows nothing	37
No sound comes out	38
Sound is interrupted or noise occurs	38
Cannot playback discs	39



Tips

I want to enjoy analog output audio at higher quality

- Set Pure Direct which turns digital output and the display off. (👉 p. 23)

I want to playback just the specified folder

- The MODE button to set the playback range to “Folder mode”. (👉 p. 31)

I want to display Super Audio CD text

- This unit supports Super Audio CD text. Press the INFO button to switch the display information. (👉 p. 26)

I want to play the multi-channel area of a Super Audio CD is played

- This unit can play multi-channel audio by downmixing to two channels. Press the DISC LAYER button and set “MULTI”. (👉 p. 24)

I want to play all tracks on a DVD-R/-RW/+R/+RW or CD-R/-RW at random

- Random playback can be set by pressing the MODE button and setting “All Mode” as the playback mode before playback.



Troubleshooting

If a problem should arise, first check the following.

1. **Are the connections correct?**
2. **Is the set being operated as described in the owner's manual?**
3. **Are the other devices operating properly?**

If this unit does not operate properly, check the items listed in the table below.

Should the problem persist, there may be a malfunction. In this case, disconnect the power immediately and contact your store of purchase.

■ Power does not turn on / Power is turned off

Symptom	Cause / Solution	Page
Power is not turned on.	• Check whether the power plug is correctly inserted into the power outlet.	<u>20</u>
	• This unit is in standby mode. Press the  button on the remote control.	<u>22</u>
Power automatically turns off.	• The Auto Standby mode is set. The Auto Standby mode switches the unit to standby mode when the unit is not operated for approximately 30 minutes.	<u>33</u>



■ Operations cannot be performed through the remote control unit

Symptom	Cause / Solution	Page
Operations cannot be performed through the remote control unit.	• Batteries are worn out. Replace with new batteries.	5
	• Operate the remote control unit within a distance of about 7 m from this unit and at an angle of within 30°.	5
	• Remove any obstacle between this unit and the remote control unit.	—
	• Insert the batteries in the proper direction, checking the ⊕ and ⊖ marks.	5
	• The unit's remote control sensor is exposed to strong light (direct sunlight, inverter type fluorescent bulb light, etc.). Move the unit to a place in which the remote control sensor will not be exposed to strong light.	—
	• When using a 3D video device, the remote control unit of this unit may not function due to effects of infrared communications between units (such as TV and glasses for 3D viewing). In this case, adjust the direction of units with the 3D communications function and their distance to ensure they do not affect operations from the remote control unit of this unit.	—

■ Display on this unit shows nothing

Symptom	Cause / Solution	Page
Display is off.	• Press the DIMMER button, and change the setting to anything other than off.	23
	• The display turns off when the Pure Direct mode is on.	23



■ No sound comes out

Symptom	Cause / Solution	Page
No sound is produced. Or sound is distorted.	• Check the connections for all devices.	<u>16</u>
	• Insert connection cables all the way in.	—
	• Check that input connectors and output connectors are not reversely connected.	—
	• Check cables for damage.	—
	• Check the amplifier's functions and controls and adjust as necessary.	—
	• Digital audio output stops during playback of the HD layer of Super Audio CDs, DSD files and files with a sampling frequency of 32 kHz.	—

■ Sound is interrupted or noise occurs

Symptom	Cause / Solution	Page
During playback from the CD-R/CD-RW/DVD-R/DVD-RW/DVD+R/DVD+RW, sound is occasionally interrupted.	• The sound may skip during playback of a CD-R/CD-RW containing a high-resolution audio source.	—
	• This may be caused by poor recording conditions, or the disc itself may be of poor quality. Use a correctly recorded disc.	—







■ Cannot playback Discs

Symptom	Cause / Solution	Page
Cannot playback when the play button is pressed, or cannot correctly play back a specific part of the disc.	<ul style="list-style-type: none"> The disc is dirty or scratched. Either clean the disc, or insert a different disc. 	45
Cannot playback DVD-R/-RW/+R/+RW or CD-R/CD-RW.	<ul style="list-style-type: none"> Discs cannot be played back unless they have been finalized. Use a finalized disc. 	40
	<ul style="list-style-type: none"> This may be caused by poor recording conditions, or the disc itself may be of poor quality. Use a correctly recorded disc. 	—
	<ul style="list-style-type: none"> Files are created in a format that is not supported by this unit. Check the formats supported by this unit. 	40
“No Disc” is displayed.	<ul style="list-style-type: none"> “No Disc” is displayed if the disc is loaded upside-down or if no disc is loaded. 	44
“Unsupported” is displayed.	<ul style="list-style-type: none"> “Unsupported” is displayed if a disc that cannot be played is loaded. 	44



Playable media

Discs

Playable media	
Super Audio CD	
CD	
CD-R	
CD-RW	
DVD-R/-RW/+R/+RW	

■ Super Audio CD

There are three types of Super Audio CDs:

- ① Single layer discs
Single layer Super Audio CD with just an HD layer.

- ② Dual layer discs

Super Audio CD with a double HD layer, offering extended playing time and high sound quality.

- ③ Hybrid discs

Two-layer Super Audio CD with an HD layer and a CD layer. The signals on the CD layer can be played on a regular CD player.

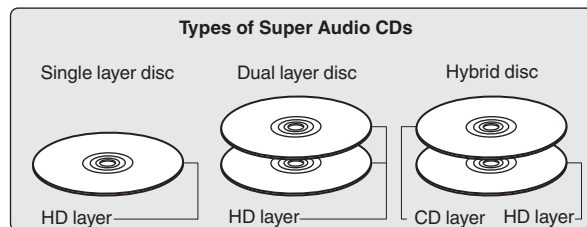

The HD layer is a layer of high density signals for Super Audio CDs. The CD layer is the layer of signals that can be read on a regular CD player.



- When "MULTI" is selected, down-mixed audio is output to the L and R channels.

NOTE

- Some discs and some recording formats may not be playable.
- Non-finalized discs cannot be played.



■ Playable files

	Sampling frequency	Bit rate	Bit length	Playable discs			Extension
				CD-R/ CD-RW	DVD-R/ DVD-RW	DVD+R/ DVD+RW	
MP3	32/44.1/48 kHz	32 – 320 kbps	–	✓	✓	✓	.mp3
WMA	32/44.1/48 kHz	48 – 320 kbps	–	✓	✓	✓	.wma
AAC	32/44.1/48 kHz	16 – 320 kbps	–	✓	✓	✓	.aac/ .m4a
WAV	32/44.1/48/88.2/ 96/176.4/192 kHz	–	16/24 bit	✓*2	✓	✓	.wav
FLAC	32/44.1/48/88.2/ 96/176.4/192 kHz	–	16/24 bit	✓*2	✓	✓	.flac
ALAC*1	32/44.1/48/ 88.2/96 kHz	–	16/24 bit	✓*2	✓	✓	.m4a
AIFF	32/44.1/48/88.2/ 96/176.4/192 kHz	–	16/24 bit	✓*2	✓	✓	.aif/ .aiff
DSD	2.8 MHz/5.6 MHz	–	1 bit	–	✓	✓	.dsf/ .dff

*1 Copyright [2012] [D&M Holdings, Inc.]

Licensed under the Apache License, Version 2.0 (the "License"); you may not use this file except in compliance with the License. You may obtain a copy of the License at <http://www.apache.org/licenses/LICENSE-2.0>

*2 This item can only be used to play files with a sampling frequency of 32/44.1/48 kHz.

■ Maximum number of playable files and folders

Maximum number of folders : 1,000

Maximum number of files in 1 folder : 2,000



NOTE

- Be sure to give files the extension. Files with any other extensions or files with no extensions cannot be played.
- Recordings you have made should only be used for your personal enjoyment, and as per copyright laws may not be used in other ways without permission of the copyright holder.



- Only music files that are not copyright-protected can be played on this unit.
 - Contents downloaded from pay sites on the Internet are copyright protected. Also, files encoded in WMA format when ripped from a CD, etc., on a computer may be copyright protected, depending on the computer's settings.
- Digital audio output stops during files with a sampling frequency of 32 kHz.
- The maximum number of files and folders that can be played differs depending on conditions such as the length of the file name or folder name or the number of levels in the folder hierarchy.

Playback order of music files

When there are multiple folders containing music files, the playback order of folders is automatically set when this unit reads the media. The files in each folder are played back in the order in which the files were recorded on the media, from the oldest date and time.

DVD-R/-RW/+R/+RW and CD-R/-RW

For playback of files on DVD-R/-RW/+R/+RW or CD-R/-RW, files in all folders on the first layer are played first, next on the second layer, then next on the third layer, and so on in this order.



- The playback order displayed on a PC may differ from the actual playback order.
- The playback order with a DVD-R/-RW/+R/+RW and CD-R/-RW may differ, depending on the writing software.



About discs and files

Music files recorded on CD-R/-RW and DVD-R/-RW/+R/+RW are divided into large segments (folders) and small segments (files).

Files are stored in folders, and folders can be placed for storage in a hierarchy. The unit can recognize up to 8 levels of folders.

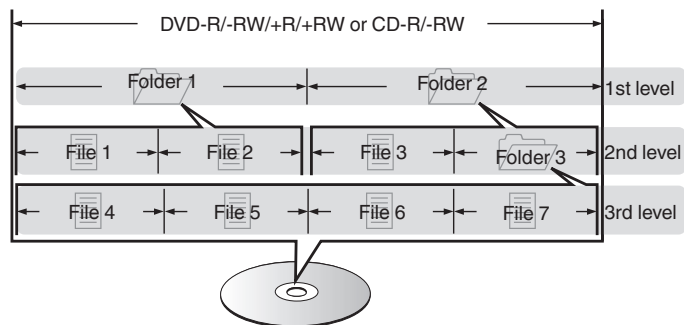

- When writing music files on a DVD-R/-RW/+R/+RW or CD-R/-RW disc, set the writing software's format to "ISO9660". The files may not play properly if they are recorded in other formats. For details, refer to the instructions of your writing software.



Cautions on using media

Inserting a disc

- Set the disc in the tray label side up.
- Make sure the disc tray is fully open when inserting the disc.
- Place the discs flatly, 12 cm discs in the outer tray guide (Figure 1), 8 cm discs in the inner tray guide (Figure 2).

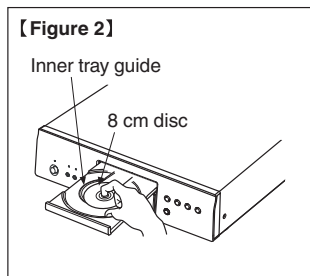
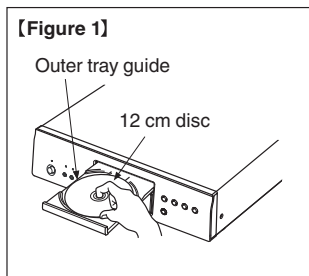

- Place 8 cm discs in the inner tray guide without using an adapter.



- "Unsupported" is displayed if a disc that cannot be played is loaded.
- "No Disc" is displayed if the disc is loaded upside-down or if no disc is loaded.

NOTE

- Only load one disc at a time. Loading two or more discs can damage the unit or scratch the discs.
- Do not use cracked or warped discs or discs that have been repaired with adhesive, etc.
- Do not use discs on which the sticky part of cellophane tape or labels is exposed or on which there are traces of where labels have been removed. Such discs can get caught inside the player and damage it.
- Do not use discs in special shapes, as they may damage the unit.



- Do not push the disc tray in by hand when the power is off. Doing so could damage the unit.
- If the unit is left in a room full of smoke from cigarettes, etc., for long periods of time, the surface of the optical pickup may get dirty, preventing it from receiving signals properly.



How to handle media

- Do not get fingerprints, oil or dirt on discs.
- Take special care not to scratch discs when removing them from their cases.
- Do not bend or heat discs.
- Do not enlarge the hole in the center.
- Do not write on the labeled (printed) surface with ball-point pens, pencils, etc., or stick new labels on discs.
- Condensation may form on discs if they are moved suddenly from a cold place (outdoors for example) to a warm place, but do not try to dry discs with a hairdryer, etc.
- Do not store discs in the following places:
 1. Places exposed to direct sunlight for long periods of time
 2. Dusty or humid places
 3. Places exposed to heat from heaters, etc.

Cleaning discs

- If there are fingerprints or dirt on a disc, wipe them off before using the disc.
- Use a commercially available disc cleaning set or a soft cloth to clean discs.



Gently wipe the disc from the inside towards the outside.

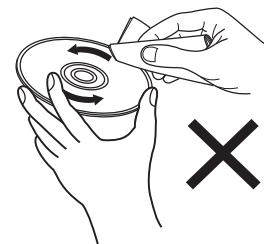

Do not wipe with a circular motion.

NOTE

- Do not use record spray, antistatic agents, benzene, thinner or other solvents.



Explanation of terms

Advanced AL32 Processing Plus

Equipped with Advanced AL32 Processing Plus, Denon's own analog waveform reproduction technology. The reproducibility of weak signals is enhanced by expanding 16 bit digital data to 32 bit.

AIFF (Audio Interchange File Format)

This is an uncompressed and lossless format for digital audio. Use AIFF files to burn high-quality audio CDs from imported songs. AIFF files use approximately 10 MB of disk space per minute.

ALAC (Apple Lossless Audio Codec)

This is a codec for lossless audio compression method developed by Apple Inc. This codec can be played back on iTunes, iPod or iPhone. Data compressed to approximately 60 – 70% can be decompressed to exactly the same original data.

DSD (Direct-Stream Digital)

One of the audio data recording methods, it is the signal aspect used to store audio signals on a super audio CD, and is Δ - Σ modulated digital audio. It is configured of an array of single bit values at a 2.8 MHz sampling rate.

FLAC

FLAC stands for Free lossless Audio Codec, and is a lossless free audio file format. Lossless means that the audio is compressed without any loss in quality.

The FLAC license is as shown below.

Copyright (C) 2000, 2001, 2002, 2003, 2004, 2005, 2006, 2007, 2008, 2009 Josh Coalson

Redistribution and use in source and binary forms, with or without modification, are permitted provided that the following conditions are met:

- Redistributions of source code must retain the above copyright notice, this list of conditions and the following disclaimer.
- Redistributions in binary form must reproduce the above copyright notice, this list of conditions and the following disclaimer in the documentation and/or other materials provided with the distribution.
- Neither the name of the Xiph.org Foundation nor the names of its contributors may be used to endorse or promote products derived from this software without specific prior written permission.



THIS SOFTWARE IS PROVIDED BY THE COPYRIGHT HOLDERS AND CONTRIBUTORS "AS IS" AND ANY EXPRESS OR IMPLIED WARRANTIES, INCLUDING, BUT NOT LIMITED TO, THE IMPLIED WARRANTIES OF MERCHANTABILITY AND FITNESS FOR A PARTICULAR PURPOSE ARE DISCLAIMED. IN NO EVENT SHALL THE FOUNDATION OR CONTRIBUTORS BE LIABLE FOR ANY DIRECT, INDIRECT, INCIDENTAL, SPECIAL, EXEMPLARY, OR CONSEQUENTIAL DAMAGES (INCLUDING, BUT NOT LIMITED TO, PROCUREMENT OF SUBSTITUTE GOODS OR SERVICES; LOSS OF USE, DATA, OR PROFITS; OR BUSINESS INTERRUPTION) HOWEVER CAUSED AND ON ANY THEORY OF LIABILITY, WHETHER IN CONTRACT, STRICT LIABILITY, OR TORT (INCLUDING NEGLIGENCE OR OTHERWISE) ARISING IN ANY WAY OUT OF THE USE OF THIS SOFTWARE, EVEN IF ADVISED OF THE POSSIBILITY OF SUCH DAMAGE.

MP3 (MPEG Audio Layer-3)

This is an internationally standardized audio data compression scheme, using the "MPEG-1" video compression standard. It compresses the data volume to about one eleventh its original size while maintaining sound quality equivalent to a music CD.

WMA (Windows Media Audio)

This is audio compression technology developed by Microsoft Corporation.

WMA data can be encoded using Windows Media® Player.

To encode WMA files, only use applications authorized by Microsoft Corporation. If you use an unauthorized application, the file may not work properly.

Sampling frequency

Sampling involves taking a reading of a sound wave (analog signal) at regular intervals and expressing the height of the wave at each reading in digitized format (producing a digital signal).

The number of readings taken in one second is called the "sampling frequency". The larger the value, the closer the reproduced sound is to the original.

Dynamic range

The difference between the maximum undistorted sound level and the minimum discernible level above the noise emitted by the device.

Downmix

This function converts the number of channels of surround audio to a lower number of channels and plays back according to the system's configuration.



Bit rate

This is the amount of audio data recorded on a disc that is read in one second.

Finalizing

This process enables CDs recorded with a CD recorder or drive to be played by other players.

Linear PCM

This is an uncompressed PCM (Pulse Code Modulation) signal. Unlike lossy compression audio sources such as MP3, no audio quality or dynamic range deteriorates.



Trademark information



Adobe, the Adobe logo and Reader are either registered trademarks or trademarks of Adobe Systems Incorporated in the United States and/or other countries.



Specifications

■ Audio performance

- Analog output

Channels:

[Super Audio CD]

2-channels

[CD]

2-channels

Playable frequency range:

2 Hz – 100 kHz

2 Hz – 20 kHz

Playable frequency response:

2 Hz – 50 kHz (-3 dB)

2 Hz – 20 kHz (± 0.5 dB)

S/N:

120 dB (Audible range)

118 dB

Dynamic range:

112 dB (Audible range)

101 dB

Harmonic distortion:

0.0006 % (1 kHz, Audible range)

0.0015 % (1 kHz)

Wow & flutter:

Below measurable limits

Below measurable limits

Output level:

2.0 V (10 k Ω /kohms)

2.0 V (10 k Ω /kohms)

Signal type:

1-bit DSD

16-bit linear PCM

Sampling frequency:

2.8224 MHz

44.1 kHz

Usable discs:

Super Audio CD

Compact Disc

- Digital output

Coaxial:

—

0.5 V_{p-p} / 75 Ω /ohms

Optical:

—

-15 — -21 dBm

Emission wavelength:

—

660 nm



■ General

Power supply: AC 230 V, 50/60 Hz

Power consumption: 25 W

Power consumption in standby mode: 0.1 W or less

For the purpose of improvement, the specifications and design are subject to change without notice.



■ Dimensions (Unit : mm)

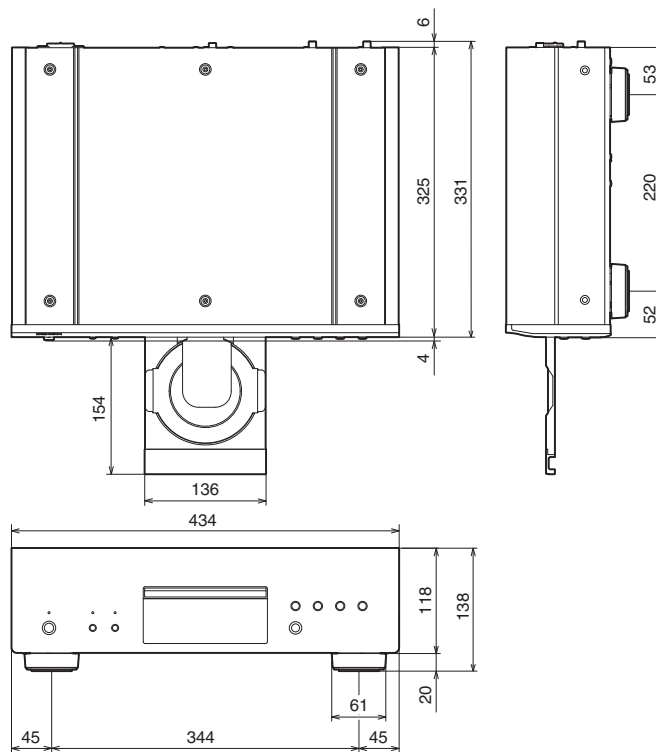

■ Weight : 13.7 kg

Index

A

Amplifier	17
Auto Standby	33
AV receiver	18

C

CD	25
----------	----

D

D/A converter	18
DATA CD	29
Display	10
Display brightness	23

F

Front panel	8
-------------------	---

P

Program playback	27
------------------------	----

R

Rear panel	11
Remote control unit	12

T

Timer device	19, 32
Tips	35
Troubleshooting	36



DENON®

www.denon.com

3520 10425 10AD

Copyright © 2015 D&M Holdings Inc. All Rights Reserved.