

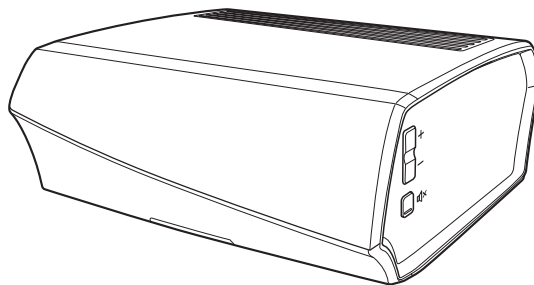

Wireless Amplifier

# Owner's Manual

HEOS Amp HS2



<b>Introduction</b>	<b>5</b>	Playing music from Bluetooth device	25
<b>Before your begin</b>	<b>6</b>	Pairing the HEOS device with your Bluetooth devices	25
System requirements	6	HEOS account	26
Network requirements	6	What is a HEOS account?	26
Controller requirements	7	Why do I need a HEOS account?	26
Getting to know your HEOS Amp	8	Signing up for a HEOS account	26
Front panel	9	Changing your HEOS account	26
Controls	10	Playing from streaming music services	27
Back panel	11	Adding a music service	27
Placing your HEOS Amp	12	Changing music service settings	27
Connecting external devices	13	Managing inputs	28
Connecting speakers	13	Changing the name of the inputs	28
Connecting a subwoofer	14	Hiding an input	28
Connecting an audio playback device	14	Managing your phone	29
Connecting a USB storage device	15	Listening to the same music in multiple rooms	30
Powering your HEOS Amp	16	Grouping rooms	30
Getting the HEOS app	16	Ungrouping rooms	31
<b>Setting up your first HEOS Amp</b>	<b>17</b>	Grouping all rooms (party mode)	32
<b>Adding more HEOS devices</b>	<b>18</b>	Ungrouping all rooms	33
Adding wired HEOS devices	18	Using the now playing queue	34
Adding wireless HEOS devices	18	Play Now	34
<b>Using your HEOS Amp</b>	<b>19</b>	Play Now & Replace Queue	34
Selecting a room	19	Play Next	34
Listening to radio	20	Add to End of Queue	34
Playing music stored on your mobile device	20	Rearranging the now playing queue	35
Playing music from your networked PC or NAS	21	Deleting songs from the play queue	35
Playing music from an external audio device	22	Deleting all songs from the play queue	36
Streaming an external audio device to any HEOS device	23	Saving playlists	36
Playing music from a USB device	24	Performing repeat and shuffle playback	36



Using the favorite	37	<b>Making adjustments</b>	<b>38</b>
Adding to HEOS favorite	37	Changing the name of a HEOS Amp	38
Deleting station from the HEOS favorite	37	Changing the wireless network connection	38
		Adjusting the equalizer	39
		Adjusting the balance	39
		Adjusting the audio quality	39
		Adjusting the volume limit	40
		Adjusting the status light brightness	40
		Advanced settings	41
		Network settings	41
		About wireless power saving	41
		Firmware upgrade	42
		About	42



<b>Updating your system</b>	<b>43</b>	<b>Status LED table</b>	<b>55</b>
<b>Advanced features</b>	<b>44</b>	<b>Supported file types and codecs</b>	<b>62</b>
Sharing music from your mobile device	44	Supported audio formats (Optical)	62
Wireless performance	44	<b>Specifications</b>	<b>63</b>
Submit diagnostics	45	<b>Information</b>	<b>65</b>
Resetting your controller app	45	Trademarks	65
<b>Power management</b>	<b>46</b>		
Power modes	46		
Quick Start Mode	46		
Deep Standby	47		
Off	47		
<b>Basic troubleshooting</b>	<b>48</b>		
My HEOS device won't connect to my network using the audio cable	48		
Cannot pair a Bluetooth mobile device with the HEOS device	49		
Cannot hear Bluetooth music	49		
My HEOS device turns off and the status LED flashes in red	50		
Music cuts out or delays sometimes	51		
I hear a delay when using the external input with my TV	51		
I hear distortion when using the AUX input	52		
Connecting to a WPS network	52		
Resetting your HEOS device	53		
Restoring the HEOS device to factory defaults	53		
Contact Denon	54		



Thank you for purchasing this HEOS product. To ensure proper operation, please read this owner's manual carefully before using the product.

#### NOTE

- THIS DOCUMENT CONTAINS INFORMATION THAT IS SUBJECT TO CHANGE WITHOUT NOTICE.  
For latest information, please visit <http://www.HEOSbyDenon.com>

## Introduction

The HEOS Amp is part of the HEOS wireless multi-room sound system that enables you to enjoy your favorite music anywhere and everywhere around your home. By utilizing your existing home network and the HEOS app on your iOS or Android™ device, you can explore, browse, and play music from your own music library or from many online streaming music services.

- True multi-room audio - play different songs in different rooms or the same song in every room
- Utilizes your existing home wireless network for quick and easy setup
- Industry leading microsecond audio synchronization between HEOS device
- Legendary Denon audio quality
- If you are in a hurry, you can be enjoying great sounding music in no time by following the steps outlined in the HEOS Quick Start Guide (packaged with your HEOS device).



Please continue reading this Owner's Manual for more detailed information about the features and benefits of your HEOS Amp.



# Before your begin

---

## NOTE

- If you have already installed at least one HEOS device, please skip to the section "Adding more HEOS devices". ([🔗 p. 18](#))

## System requirements

Before you begin installing your first HEOS device, please make sure you understand and meet a few basic requirements.

### ■ Network requirements

**Wireless Router** - In order to use your HEOS music system, you must have a working wireless (Wi-Fi) or ethernet network in your home. Even when connected to an Ethernet network, a Wi-Fi connection to the router is required to control the system using the HEOS Control app. If you do not have a wireless network, please contact your local Denon dealer or electronics retailer to assist you with purchasing and installing a wireless network in your home.

**High Speed Internet Connection** - HEOS accesses the Internet to stream music to your home from many popular online music services. HEOS is also designed to provide you with software updates, which are delivered via your home Internet connection. DSL, Cable, and Fiber services will provide the best experience and reliability. You may experience performance issues with slower Internet connections like satellite based services.



## ■ Controller requirements

You can control your HEOS wireless multi-room sound system using the free HEOS app on any iOS or Android mobile device that meets these minimum requirements:



### iOS Minimum Requirements

- iOS version 8.0 or later
- iPhone® 4S or newer
- iPad® 2 or newer
- iPod touch® (5th generation) or newer



### Android Minimum Requirements

- Android OS version 4.0 or later
- All resolutions



## Getting to know your HEOS Amp

Unpack your HEOS Amp from the box and verify that the following items are included:

① HEOS Amp

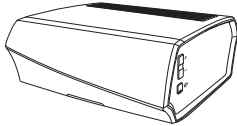

② Quick Start Guide



③ Safety Instructions



④ Warranty (North America model only)



⑤ Extended Protection Plan (North America model only)



⑥ Audio/Setup cable

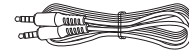

⑦ Ethernet cable

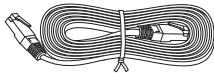

⑧ Power cord

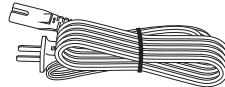

### NOTE

- Please use the power cord included in the box for your device.





## ■ Front panel

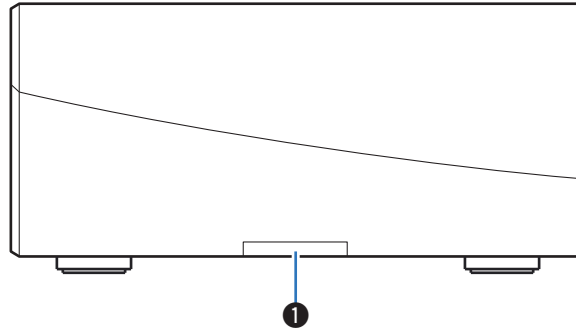

### ① Status LED

Please refer to the “Status LED table” for LED color and state meaning. (☞ p. 55)



## ■ Controls

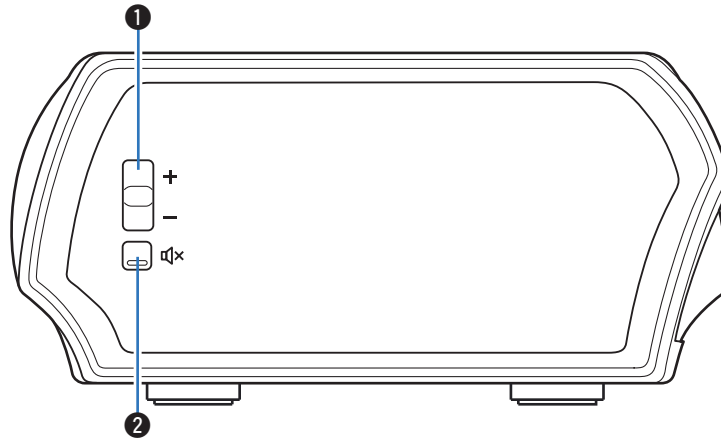

**1 Volume up/down buttons (+, -)**

Adjusts the HEOS device's volume level up or down.

**2 Mute button (🔇)**

Mutes or unmutes the HEOS device's volume.



## ■ Back panel

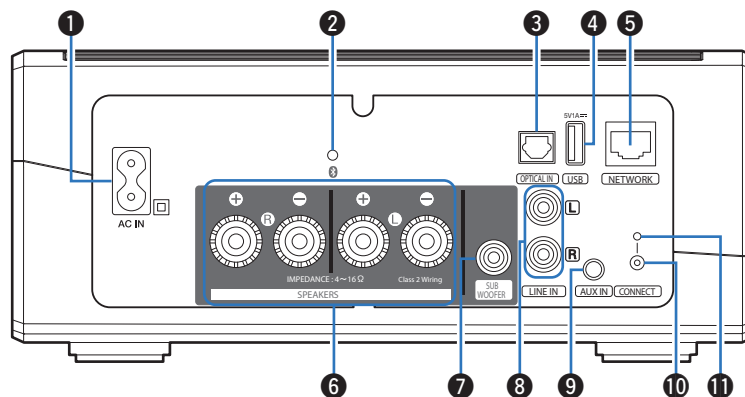

### ❶ AC inlet (AC IN)

Used to connect the power cord. (☞ p. 16)

### ❷ Bluetooth button (📶)

Used in the Bluetooth pairing settings. (☞ p. 25)

### ❸ Digital Audio Input (OPTICAL IN)

Used to connect audio devices with a digital optical cable. (☞ p. 14)

### ❹ USB Input (USB 5 V/1 A)

Used to connect USB storage devices. (☞ p. 15)

### ❺ NETWORK connector

Used to connect this unit to a wired Ethernet network. (☞ p. 18)

### ❻ Speaker terminals (SPEAKERS)

Used to connect speakers. (☞ p. 13)

### ❼ Subwoofer connector (SUBWOOFER)

Used to connect this unit to a powered subwoofer. (☞ p. 14)

### ❽ Analog audio connectors (LINE IN)

Used to connect audio devices with a stereo RCA cable. (☞ p. 14)

### ❾ AUX jack (AUX IN)

Used to connect audio devices with a 1/8 inch (3.5 mm) cable. (☞ p. 14)

Used to add the HEOS device to your wireless network. (☞ p. 17)

### ❿ CONNECT button

Used for Wi-Fi setup.

### ⓫ Connect in status LED

Indicates the status of this unit. (☞ p. 55)



## Placing your HEOS Amp

The HEOS Amp is designed to add HEOS multi-room audio functionality to an external device which offers audio amplification. You should place your HEOS Amp in a convenient location near the speakers you are connecting it to.

- The HEOS Amp must be within range of your wireless network.
- The HEOS Amp is not waterproof. Do not place it near any water source and do not leave it outside in the rain or snow.

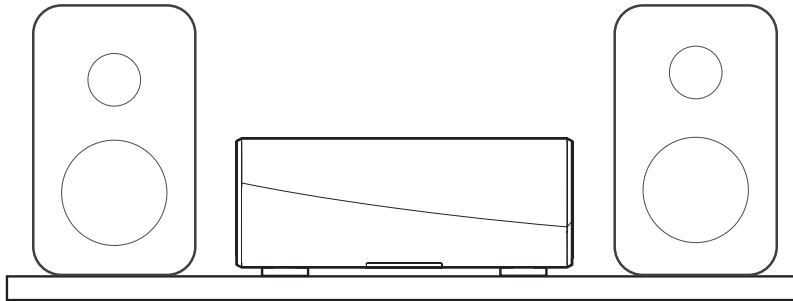

## Connecting external devices

### ■ Connecting speakers

Carefully check the left (L) and right (R) channels and + (red) and – (black) polarities on the speakers being connected to this unit, and be sure to connect the channels and polarities correctly.

- 1 Peel off about 3/8 inch (10 mm) of sheathing from the tip of the speaker cable, then either twist the core wire tightly or terminate it.



- 2 Turn the speaker terminal counterclockwise to loosen it.



- 3 Insert the speaker cable's core wire to the hilt into the speaker terminal.



- 4 Turn the speaker terminal clockwise to tighten it.



#### NOTE

- Disconnect this unit's power plug from the power outlet before connecting the speakers. Also, turn off any connected powered subwoofers.
- Connect so that the speaker cable core wires do not protrude from the speaker terminal. The protection circuit may be activated if the core wires touch the rear panel or if the + and – sides touch each other.
- Never touch the speaker terminals while the power cord is connected. Doing so could result in electric shock.
- Use speakers with an impedance of 4 – 16  $\Omega$ /ohms. The protection circuit may be activated if speakers with an impedance other than specified are used.
- Depending on the speakers that are connected, the protection circuit may activate and the power may be turned off when music is played at a high volume (The Status indicator flashes in red). If this happens, configure the "Volume Limit" setting. (☞ p. 40)

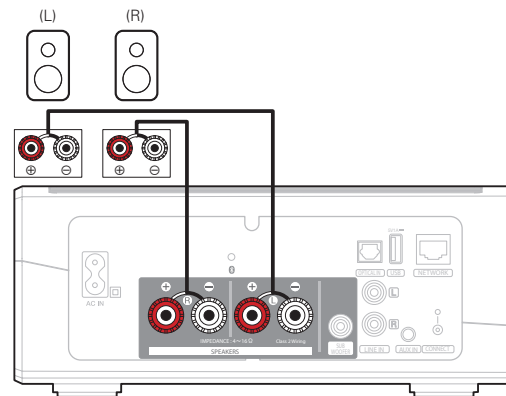

## ■ Connecting a subwoofer

Connect the SUB WOOFER output to an input on your powered subwoofer or your subwoofer amplifier.

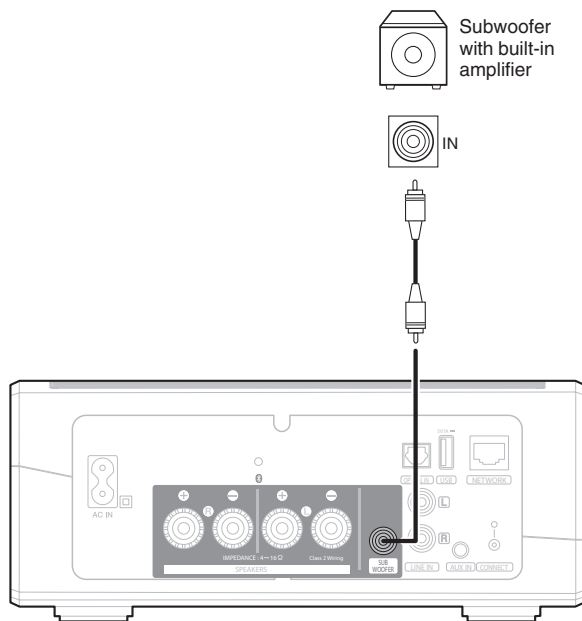

## ■ Connecting an audio playback device

Connect the LINE IN, AUX IN or OPTICAL IN input to an audio playback device (CD player, portable music player, etc...) using the appropriate cables.

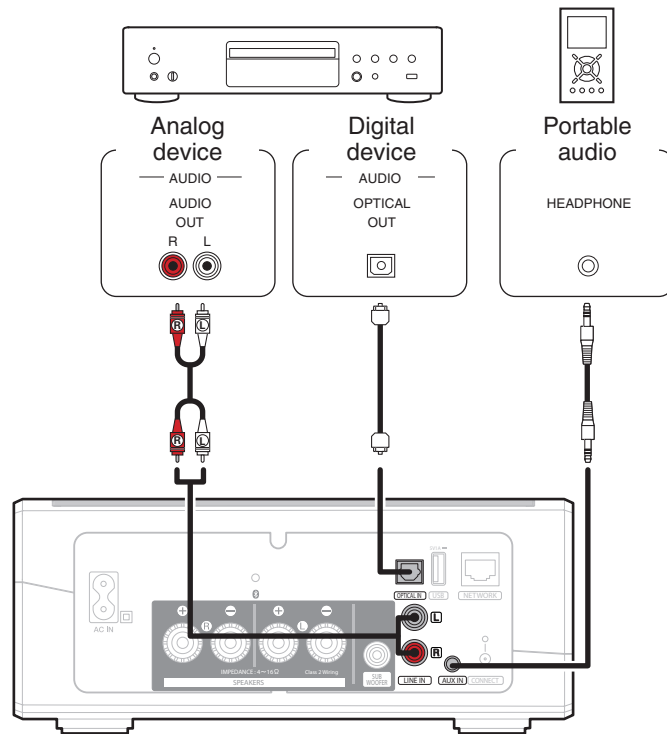

## ■ Connecting a USB storage device

Connect a FAT32 formatted USB storage device containing digital music files to any available USB port.

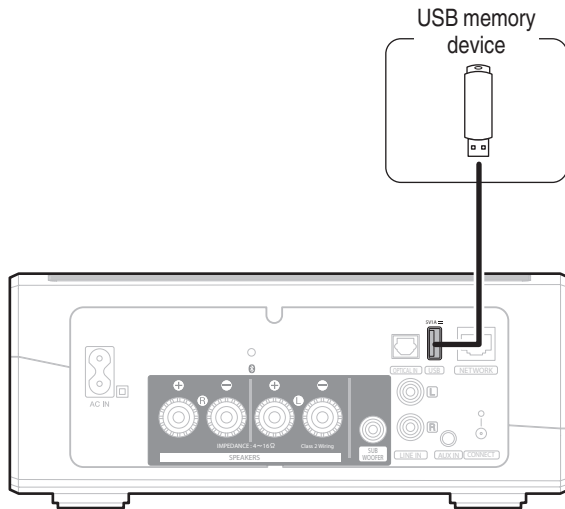

## Powering your HEOS Amp

Connect the power cord included in the box to the back of the HEOS Amp and the plug to a wall outlet.

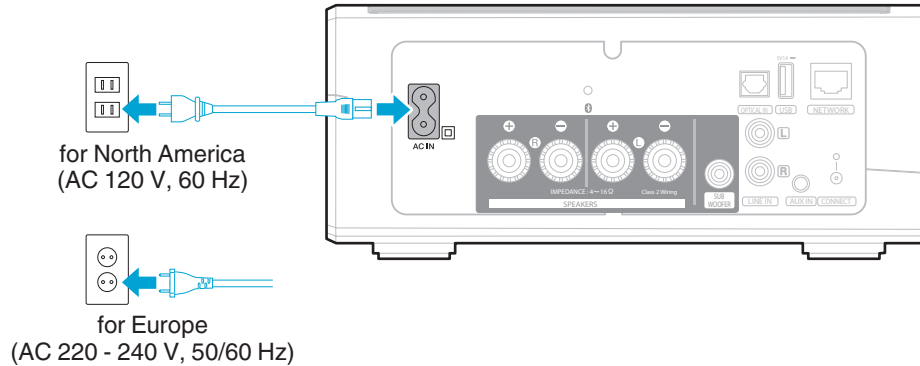

## Getting the HEOS app

The HEOS app is the heart of the HEOS experience. Using your mobile device and the HEOS app, you can setup, browse, explore, and control your HEOS system right in the palm of your hand, from anywhere in your home.

Download the HEOS app for iOS or Android by searching App Store®, Google Play™ store or Amazon App Store for “HEOS”.



For the purpose of improvement, the specifications and design are subject to change without notice.





# Setting up your first HEOS Amp

Once you have placed your HEOS Amp in your listening room and have downloaded the HEOS app, you are ready to configure your HEOS Amp for music playback. This involves following a few simple steps to get the HEOS Amp connected to your existing home network:

## Caution

- DO NOT connect the Ethernet cable if you are connecting your HEOS Amp to a wireless network. If you are connecting the HEOS Amp to a wired network, use an Ethernet cable to connect the HEOS Amp to your network or router.

## 1 Make sure your mobile device is connected to your wireless network (the same network you want your HEOS Amp connected to).

You can check this in the Settings - Wi-Fi menu of your iOS or Android device.

## NOTE

- If your wireless network is secure, make sure you know the password to join your network.

## 2 Make sure you have the included Audio/Setup cable handy.

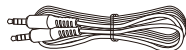

## 3 Launch the HEOS app on your mobile device.



## 4 Tap the “Setup Now” button at the top of the screen.

## 5 Follow the instructions to add the HEOS Amp to your wireless network.

The Wi-Fi settings from your mobile device will be copied to the HEOS Amp via the audio cable.

## NOTE

- If you have any problems connecting your HEOS device, jump to the Troubleshooting section. ([🔗 p. 48](#))



## Adding more HEOS devices

The HEOS wireless multi-room sound system is a true multiroom audio system that automatically synchronizes audio playback between multiple HEOS devices so that the audio coming from different rooms is perfectly in sync and always sounds amazing! You can easily add up to 32 devices to your HEOS system.

### Adding wired HEOS devices

Just connect the HEOS devices to your home network using an Ethernet cable and the HEOS devices will appear on your HEOS app as a new room in the “Rooms” screen.

At your convenience, you can assign a name to the HEOS devices to indicate which room you have it placed in.



- Use only a shielded STP or ScTP LAN cable which is easily available at electronics stores (CAT-5 or greater recommended).
- Do not connect a Network Connector directly to the LAN port/Ethernet connector on your computer.

### Adding wireless HEOS devices

You can add additional wireless HEOS devices to your HEOS system by selecting “Add Device” from the HEOS app’s settings menu and follow the instructions:

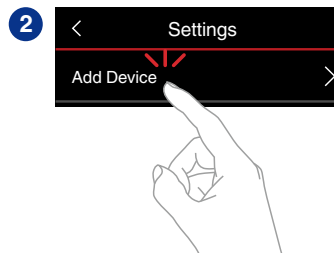
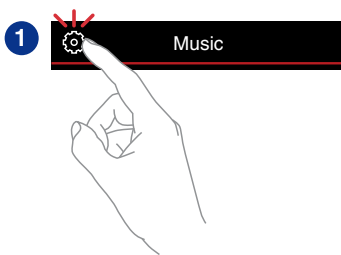

# Using your HEOS Amp

Once you have your HEOS device connected to your network and the HEOS app installed on your mobile device, it's easy to start enjoying your favorite music. You can listen to something different in every room or the same music perfectly synchronized in all rooms. It's up to you!

## Selecting a room

If you have more than one HEOS device, you must tell the HEOS system which one you want to control:

- 1 Tap the “Rooms” tab.
- 2 Select the Room you want to control.
- 3 Select the “Music” tab to select a music source or the “Now Playing” tab to control what is currently playing in the selected room.

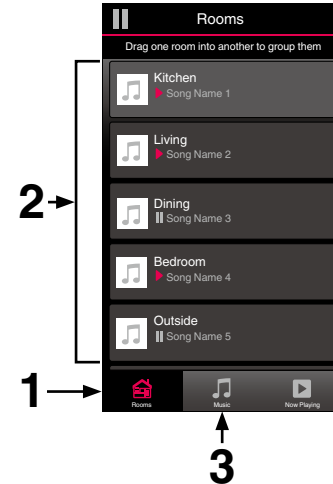

## Listening to radio

The HEOS system includes access to more than 100,000 free internet radio streams from all corners of the globe via the TuneIn radio service. Just select the TuneIn logo from the main “Music” menu and browse among the 100,000 stations neatly organized into popular categories and select a station that appeals to your mood.

### NOTE

- If you have a TuneIn account, you can sign into the TuneIn service under “Settings” - “Music Sources” - TuneIn, and access all of your “My Favorites” TuneIn stations.

■ ■ ■ Audio signal

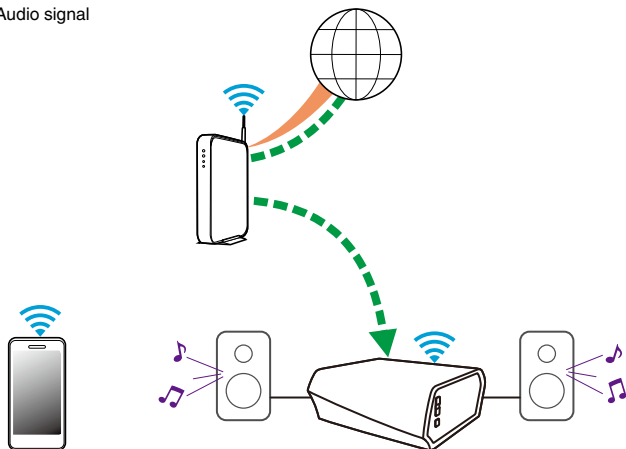

## Playing music stored on your mobile device

- 1 Tap the “Music” tab.
- 2 Select “This iPhone/iPod/iPad/Phone”.
- 3 Browse the local music on your phone and select something to play.

■ ■ ■ Audio signal

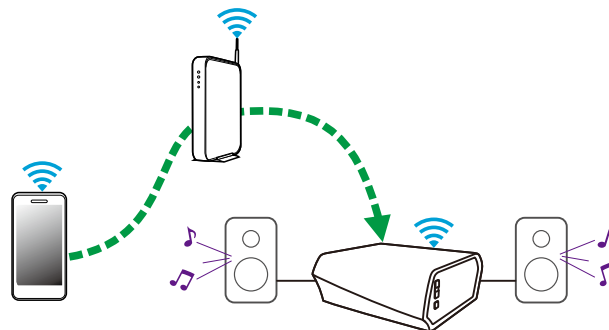

## Playing music from your networked PC or NAS

- 1 Select “Music Servers” from the “Music” tab.
- 2 Select the name of your networked PC or NAS (Network Attached Storage) server.
- 3 Browse the music on your PC/NAS and select something to play.

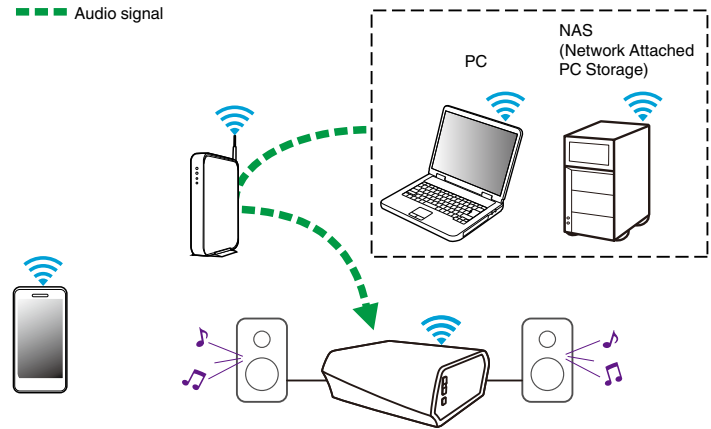

## Playing music from an external audio device

- 1** Connect an external audio device to the digital optical, analog RCA stereo or analog 3.5mm stereo input on the back of the HEOS Amp.
- 2** Select “Inputs” from the “Music” tab.
- 3** Select the name of the HEOS Amp and which input to which you connected the audio device in step 1.
- 4** Initiate playback on the audio device.

### NOTE

- When a stereo audio cable is connected to AUX IN, the source automatically switches to Inputs.

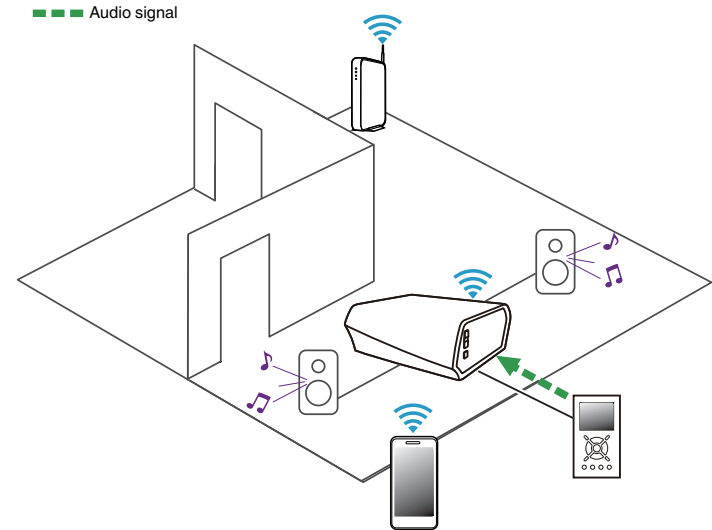

## Streaming an external audio device to any HEOS device

The sound from the audio device can be played directly on the selected device or digitized and sent over your network to other HEOS devices.

- 1** Connect an external audio device to the digital optical, analog RCA stereo or analog 3.5mm stereo inputs on the back of the HEOS Amp.
- 2** Select “Inputs” from the “Music” tab.
- 3** Select the name of the HEOS Amp and which input to which you connected the audio device in step 1.
- 4** Initiate playback on the audio device.

### NOTE

- When a stereo audio cable is connected to AUX IN, the source automatically switches to Inputs.

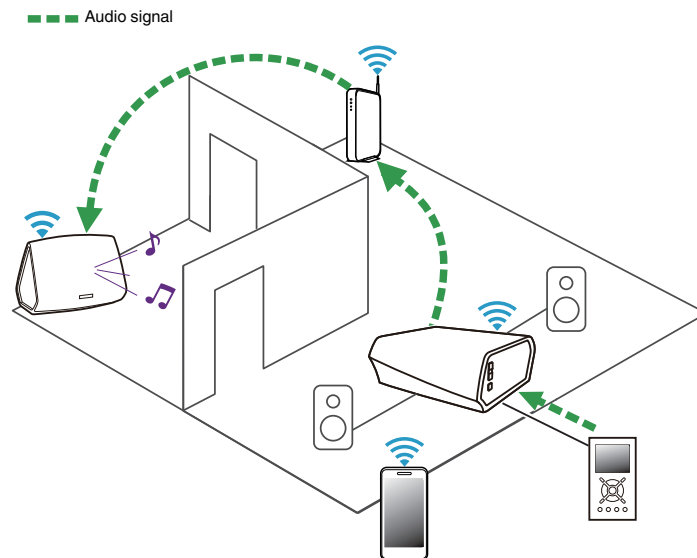

## Playing music from a USB device

- 1** Insert a FAT32 formatted USB device into the USB port on the back of the HEOS Amp.
- 2** Select “USB Music” from the “Music” tab.
- 3** Select the name of your HEOS device.
- 4** Browse the music on your USB device and select something to play.

### NOTE

- It may take several minutes for the name of your HEOS device to appear in the “USB Music” list if you have a large number of files on your USB device.
- It is not possible to connect and use a computer via the USB port of this unit using a USB cable.

■ ■ ■ Audio signal

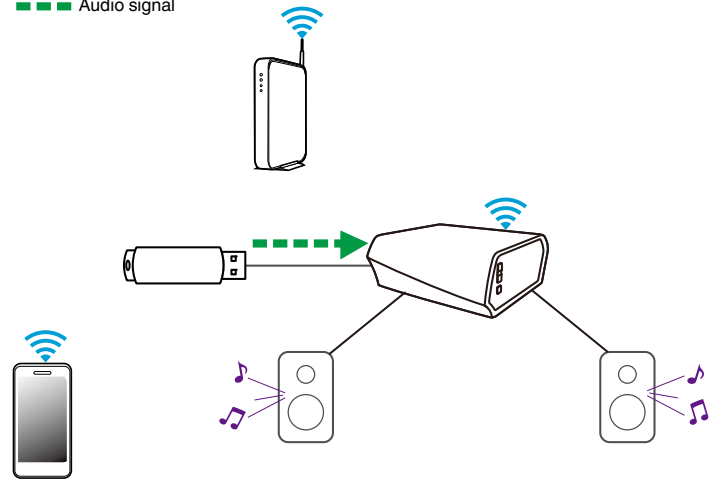



## Playing music from Bluetooth device

### ■ Pairing the HEOS device with your Bluetooth devices

- 1 Activate the Bluetooth setting on your mobile device.
- 2 Press and hold the Bluetooth button (📶) located on the back of the HEOS Amp for 3 seconds and release the button when you see a pattern of two green flashes on the status LED.
- 3 Select “HEOS Amp” from the list of available Bluetooth devices.  
In a few seconds your mobile device will indicate that it is connected to your HEOS Amp.
- 4 Play music using any app on your device. The sound will now play from the HEOS Amp.

#### NOTE

- Disconnect and reconnect Bluetooth connections from your Bluetooth device.

■ ■ ■ Audio signal

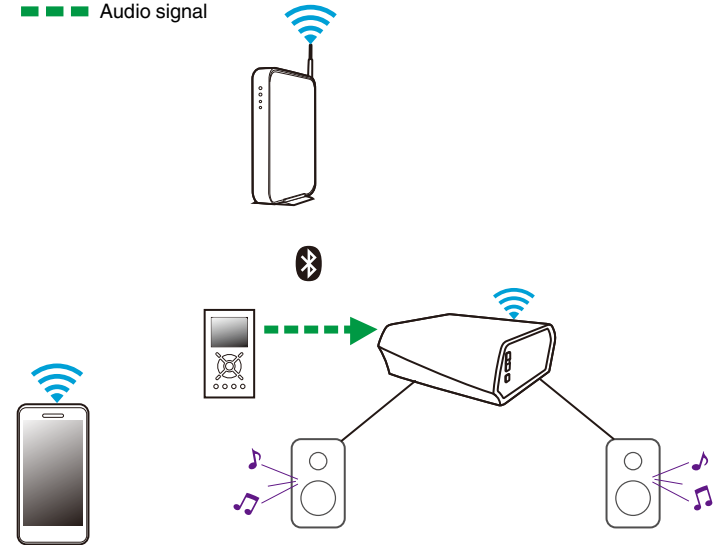

## HEOS account

### ■ What is a HEOS account?

A HEOS account is master account or “keychain” for managing all of your HEOS music services with one single username and password.

### ■ Why do I need a HEOS account?

With the HEOS account you just have to enter your music services login names and passwords one time. This allows you to easily and quickly use multiple controller apps on different devices. You just log into your HEOS account on any device and you will have access to all of your associated music services, play history and custom playlists, even if you are at a friend’s house listening to music on their HEOS system.

### ■ Signing up for a HEOS account

You will be instructed to signup for a HEOS account the first time you try to access any music service from the main “Music” menu of the HEOS app.

### ■ Changing your HEOS account

- 1 Tap the “Music” tab.
- 2 Select the Settings  icon in the upper left corner of the screen.
- 3 Select “HEOS Account”.
- 4 Change your location, change your password, delete your account or sign out of your account.



## Playing from streaming music services

A music service is an online music company that provides access to vast music collections via free and/or paid subscriptions. Depending upon your geographical location, there are several options to choose from. For more information about which services are available in your area please visit <http://www.HEOSbyDenon.com>

### ■ Adding a music service

Once you've setup your HEOS account, you can add supported music services to your HEOS system by tapping on the music service logo in the "Music" tab.

Follow the instructions on the screen to add your username and password for the selected music service. You only have to enter your account information once as the HEOS account service will securely remember your login information so you don't have to enter it each time you want to play music from the music service.

Additional music services may be available under "Settings" - "Music Sources" - "Online Music".

### ■ Changing music service settings

- 1 Tap the "Music" tab.
- 2 Select the Settings  icon in the upper left corner of the screen.
- 3 Select "Music Sources".
- 4 Select "Online Music".
- 5 Select the name of the online music service you want to edit.
- 6 Sign out, then sign in again to associate your username and password with your HEOS account.
- 7 Select "Hide for Now" to prevent the service logo from appearing on the main "Music" menu.



## Managing inputs

If you connected external audio source components to any of your HEOS devices inputs, you can rename the default input names to describe the actual source or hide any inputs that are not being used.

- 1** Select the **Settings**  icon located in the upper left corner of the main “Music” menu to display the Settings menu.
- 2** Select “Music Sources”.
- 3** Select “Inputs”.
- 4** Select the HEOS devices which you connect your external audio source device to.

### ■ Changing the name of the inputs

- 1** Select the name of the input you want to edit.
- 2** Select “Name”.
- 3** Select or enter a new name to describe the source that you connected.
- 4** Select the Save button to save your changes.

### ■ Hiding an input

- 1** Select the name of the input you want to edit.
- 2** Toggle “Hide Input” to ON to prevent this input from appearing under the Inputs tile on the main “Music” menu.



## Managing your phone

Your smartphone or tablet can be hidden if it does not need to be in the “Music Sources” menu.

- 1** Select the **Settings**  icon located in the upper left corner of the main “Music” menu to display the Settings menu.
- 2** Select “Music Sources”.
- 3** Select “This iPhone/iPod/iPad/Phone”.
- 4** Toggle “This iPhone/iPod/iPad/Phone” to OFF to prevent the service logo from appearing on the main “Music” menu.



## Listening to the same music in multiple rooms

The HEOS system is a true multiroom audio system that automatically synchronizes audio playback between multiple devices so that the audio coming from different rooms is perfectly in sync and always sounds amazing!

You can easily add up to 32 devices to your HEOS system.

You can join or group up to 16 individual HEOS devices into a group of HEOS devices that function as if they were a single HEOS device.

### ■ Grouping rooms

- 1** Tap the “Rooms” tab.
- 2** Press and hold your finger on room that is not playing music.
- 3** Drag it into the room that is playing music (indicated by the red outline) and lift your finger.

The two rooms will be grouped together into a single device group and both rooms will be playing the same music in perfect sync.



## ■ Ungrouping rooms

- 1 Tap the “Rooms” tab.
- 2 Press and hold your finger on room that you want to remove from the group.

### NOTE

- You can not remove the first room that started playing the music before grouping.

- 3 Drag it out of the group and lift your finger.

Music will stop playing in the room you dragged out of the group but will continue playing in any remaining rooms.

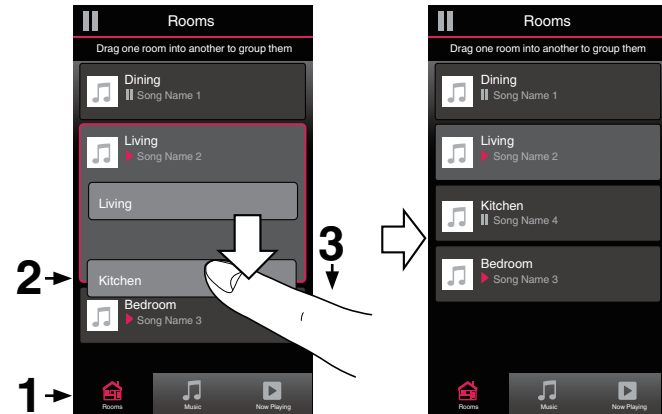

## ■ Grouping all rooms (party mode)

You can easily group 16 rooms together into Party Mode by using a “pinch” gesture.

- 1 Tap the “Rooms” tab.
- 2 Place two fingers on the screen over the list of rooms.
- 3 Quickly pinch your two fingers together and release.

All of your rooms will be joined together and begin playing the same music in perfect sync.

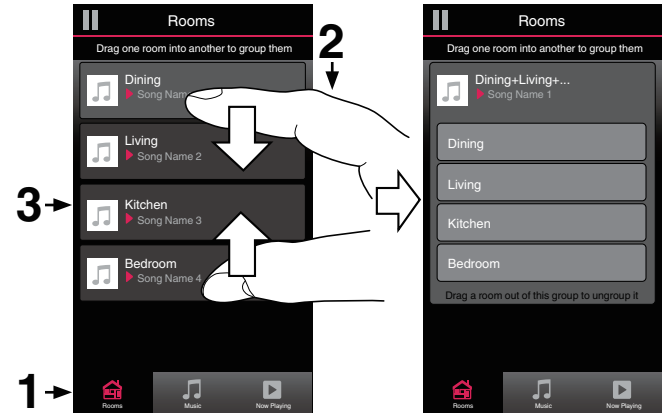



## ■ Ungrouping all rooms

You can easily ungroup all of your rooms and exit Party Mode by using a “spread” gesture.

- 1 Tap the “Rooms” tab.
- 2 Place two fingers close together on the screen over list of rooms.
- 3 Quickly spread your two fingers apart from each other and release.

All of your rooms will be ungrouped and music will stop playing in every room (except the original “master” room that was playing before you grouped the rooms together).



## Using the now playing queue

HEOS uses a Now Playing “Queue” to line up music that you want to listen to. Music can be selected from any of your local or online music sources (as long as they are not preprogrammed “radio” or “station” type streams). This feature works similarly to how a jukebox works. You select something to play (a song, album, playlist or even your entire music collection) and add it to the “Queue”. When you select something to play you will be asked how you want to queue up your music.

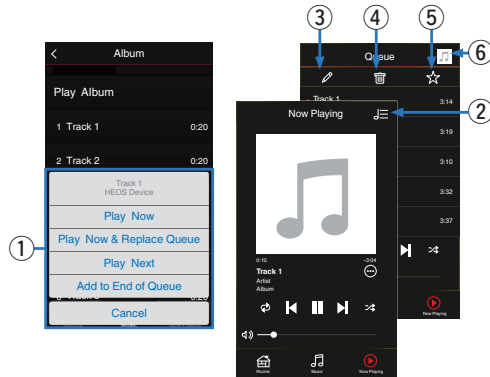

### 1 Queue Menu

When you select something to play you will be asked how you want to queue up your music.

### 2 Queue icon

### 3 Pencil icon

### 4 Delete icon

### 5 Save icon

### 6 Cover art or HEOS icon

You can return to the “Now Playing” screen display by tapping the cover art or the HEOS icon.

### ■ Play Now

Inserts the item into the queue after the currently playing track and plays the selected item immediately.

### ■ Play Now & Replace Queue

Clears the queue and plays the selected item immediately.

### ■ Play Next

Inserts the item into the queue after the current song and plays it when the current song ends.



### ■ Add to End of Queue

Adds the item to the end of the queue.





## Rearranging the now playing queue

Once you have songs lined up in your queue, you might want to rearrange the order or remove some songs:

- 1 Tap the “Now Playing” tab.
- 2 Tap the Queue  icon in the upper right corner of the screen.
- 3 Tap the Pencil  icon to enter Edit mode.
- 4 Rearrange the order of your queue by dragging the list  icon (on the right side of each track row) up or down.

## Deleting songs from the play queue



You can remove songs one at a time from the Now Playing Queue:

- 1 Tap the “Now Playing” tab.
- 2 Tap the Queue  icon in the upper right corner of the screen.
- 3 Tap the Pencil  icon to enter Edit mode.
- 4 Tap the track(s) that you want to delete.
- 5 Tap the Delete  icon to delete all of the selected tracks from the play queue.





## Deleting all songs from the play queue

You can remove all of the songs from the Now Playing Queue:

- 1 Tap the “Now Playing” tab.
- 2 Tap the Queue  icon in the upper right corner of the screen.
- 3 Tap the Delete  icon to confirm that you want to delete all songs from the queue.



## Saving playlists

You can save the Now Playing Queue as a HEOS Playlist that you can recall later. The new playlist will be available from the Playlists button on the “Music” tab on every controller app connected to your HEOS system.

- 1 Tap the “Now Playing” tab.
- 2 Tap the Queue  icon in the upper right corner of the screen.
- 3 Tap on the Save  icon.
- 4 Enter a name for your Playlist and tap the  icon.

## Performing repeat and shuffle playback

The playback controls are visible on the “Now Playing” screen.

- 1 Tap the “Now Playing” tab.
- 2 Tap the repeat  and shuffle  controls.



## Using the favorite

HEOS uses a "HEOS Favorites" to line up station you want to start play quickly the favorite stations. Station can be selected from online music sources such as "Radio" or "Station" type streams. "HEOS Favorites" will display a list of the stations of various services.

### ■ Adding to HEOS favorite

Select a station of an online music source. When the action menu screen is displayed, select "Add Station to HEOS Favorites".

#### NOTE

- This can also be done by selecting "Add Station to HEOS Favorites" from the station menu of the station being played.

### ■ Deleting station from the HEOS favorite

- 1 Tap the "Music" tab.
- 2 Select "Favorites".
- 3 Tap the Pencil  icon to enter Edit mode.
- 4 Tap the "Delete" that you want to delete station.



## Making adjustments

You can adjust specific settings for each of your HEOS Amps in your system:

- 1 Select the **Settings**  icon located in the upper left corner of the main “Music” menu to display the Settings menu.
- 2 Select “My Devices” to display a list of your HEOS devices.
- 3 Select the HEOS Amp you want to adjust.

### Changing the name of a HEOS Amp

- 1 Select “Name”.
- 2 Select or enter a new name for your HEOS Amp.
- 3 Tap the  icon to save your changes.

### Changing the wireless network connection

- 1 Select “Network”.
- 2 A list of wireless networks that your HEOS Amp can access is displayed.
- 3 Select the network you want your HEOS Amp to join.
- 4 Wait as the HEOS Amp’s network connection is changed.

#### NOTE

- Wired networking is automatically selected when the device is connected to a wired Ethernet network. To switch back to using a wireless network you must remove the Ethernet cable from the back of the device.



## Adjusting the equalizer

- 1 Select “EQ”.
- 2 Adjust the “Treble” or “Bass” up or down.



- Select the Reset button to restore the default settings.

## Adjusting the balance

- 1 Select “Balance”.
- 2 Adjust the Balance to the left or right.

## Adjusting the audio quality

Selects the transcoding option for rebroadcasting audio from one HEOS device to another HEOS device (or group of devices) across the network. When set to high bit rate audio sources originating from the first device (such as Analog input, WAV, FLAC and PCM) will be transcoded to ensure the highest level of reliability for the audio stream. (🔗 p. 23)

- 1 Select “Quality”.
- 2 Select “Normal” (default) or “High”.



- If you have selected High and you experience audio dropouts when streaming sources from one device to other devices, please select Normal (default).



## Adjusting the volume limit

You can set the maximum volume of the HEOS amplifiers to prevent sudden loud volume.

- 1** Select “Volume Limit”.
- 2** Select the maximum volume percentage (95, 90, 85, 80).

### NOTE

- Depending on the speakers that are connected, the protection circuit may activate and the power may be turned off when music is played at a high volume. (The Status indicator flashes in red.) If this happens, configure the “Volume Limit” setting.

## Adjusting the status light brightness

- 1** Select “Status Light”.
- 2** Adjust the brightness up or down or set the slider to the OFF position to completely disable the status light.





## Advanced settings

### Caution

- Adjusting these settings may disconnect your device from your network and possibly render your device unusable. Do not use these features unless you are comfortable making advanced adjustments.

### ■ Network settings

- 1 Select “Advanced”.
- 2 Select “NETWORK SETTINGS” tab.
- 3 Scroll down to see all of the options for
  - a. Network Interface (Ethernet or Wireless)
  - b. Wireless Settings
  - c. IP Address Settings (Automatic or Manual)
  - d. Wireless Power Saving
- 4 Select “Save Settings” to apply the new settings or “Cancel Changes” to revert to the previous settings.

### ■ About wireless power saving

The Wireless Power Saving feature saves power by turning off power to the wireless radio inside the HEOS device when the device is connected to an Ethernet network. If you disconnect the Ethernet cable from the HEOS device, Wireless Power Saving will automatically turn off and the wireless radio will turn on so that the HEOS device can be discovered over your wireless network.

### NOTE

- If Wireless Power Savings is ON, Wi-Fi power will be temporarily turned on when accessing the My Devices - (My Devices) - Network screen in the HEOS app or whenever the Connect button on the device is pressed.



## ■ Firmware upgrade

- 1 Select “Advanced”.
- 2 Select “FIRMWARE UPDATE” tab.
  - Update status

---

  - Manually check for a firmware upgrade.

---

  - Allow updates

---

  - ON  
(Default): Allows updates

---

  - OFF: Does not allow updates

---
- 3 Select “Save Settings” to apply the new settings or “Cancel Changes” to revert to the previous settings.

## ■ About

Viewing technical details about the HEOS device.

- 1 Select “Advanced”.
- 2 Select “ABOUT” tab.
- 3 Scroll down to see information about the device’s
  - a. Hardware
  - b. Software
  - c. Device



# Updating your system

HEOS has the ability to add enhancements and updated functionality via your high speed Internet connection. Follow the instructions on the screen to update the HEOS device and/or your controller App.

- 1** Select the Settings  icon located in the upper left corner of the main “Music” menu to display the Settings menu.
- 2** Select “Software Update”.

## Check for Update

---

Follow the instructions on screen to install any available updates to your HEOS system.

---

## Auto-Update

---

**ON (Default):** Valid updates are performed automatically.

---

**OFF:** You will be notified of valid updates on the HEOS app.

---



## Advanced features

There are a few advanced features of the HEOS system that you may want to explore once you become familiar with the basic operations. You can access the advanced features of the HEOS system by following these steps:

- 1** Select the **Settings**  icon located in the upper left corner of the main “Music” menu to display the **Settings** menu.
- 2** Select “**Advanced Settings**” to display a list the available settings.

### Sharing music from your mobile device

The HEOS app has a feature called “Music Sharing” which can share the local music stored on your mobile device to other HEOS app users on your local network. To enable this feature, select “Music Sharing”, and set it on “ON”.

The name of the device you are sharing from will appear as a music server allowing other HEOS controller apps to browse and play music from the your device.

### Wireless performance

You can check the wireless connection status of your HEOS device.

#### Quality

---

**Excellent / Good / Poor**

---

#### NOTE

- If the quality level of your HEOS device is “Poor”, make sure your HEOS devices are not located near other electronic devices that could interfere with it’s wireless connectivity (like microwave ovens, cordless phones, TVs, etc...)

#### Signal

---

**Excellent / Good / Poor**

---

#### NOTE

- If the signal level of your HEOS device is “Poor”, make sure your HEOS devices are within range of your wireless network.



## Submit diagnostics

If you are having trouble with your network or HEOS system, you may be asked by Denon technical support personnel to select this option. This feature will automatically send Denon technical support diagnostic information about your HEOS system.

### NOTE

- No personal information is sent and your information will never be shared with anyone.

## Resetting your controller app

This feature will reset the control app to its original state when you first installed it on your mobile device without requiring you to remove, download, and reinstall it from the app store.



# Power management

## Power modes

### ■ Quick Start Mode

HEOS device automatically enters "Quick Start Mode" to save power in the following cases. This unit will automatically resume to full power whenever the device is selected and playing music.

The status LED dims when the mode is switched to Quick Start Mode.

#### ❑ Ethernet

After around 20 minutes of no operation and no network access after playing music via Ethernet.

#### ❑ Wi-Fi

After around 20 minutes of no operation and no network access after playing music via Wi-Fi.

#### ❑ USB

After around 20 minutes of no operation and no network access after playing music from a USB memory device.

#### ❑ Bluetooth

After the Bluetooth connection is disconnected and there is around 20 minutes of no operation and no network access after playing music via Bluetooth.

#### ❑ AUX IN

After around 20 minutes of no operation after AUX cable is disconnected.

#### ❑ OPT IN

After around 20 minutes of no operation after optical device playback is stopped in the HEOS app.



## ■ Deep Standby

The device also has the ability to automatically enter “Deep Standby” whenever the wired or wireless network connection is removed for more than 60 minutes in “Quick Start Mode”. The front panel LED will turn off during Deep Standby.

To “wake” a HEOS device from Deep Standby, you must press the volume or mute buttons which will immediately turn on the front panel LED.



- You also push the mute button for 3 seconds, the device enters the Deep Standby.

## ■ Off

To completely turn off the power to the device you must remove the mains plug from the power outlet.



## Basic troubleshooting

### My HEOS device won't connect to my network using the audio cable

Solution	Refer to Page
<ul style="list-style-type: none"><li>• Make sure your mobile device is connected to your wireless network before setting up your device.</li><li>• Alternatively, you can connect your device to your network router using the included Ethernet cable. Once connected via Ethernet, the HEOS App should recognize the device and you can manually move it to your wireless network using Settings/My Devices/Device_Name/Advanced/Network Settings.</li></ul>	<u>17</u> <u>18</u>





## Cannot pair a Bluetooth mobile device with the HEOS device

Solution	Refer to Page
<ul style="list-style-type: none"> <li>The connection from the Bluetooth mobile device is malfunctioning. Power cycle the mobile device, remove the pairing information and re-pair the HEOS Amp to the mobile device.</li> </ul>	-

## Cannot hear Bluetooth music

Solution	Refer to Page
<ul style="list-style-type: none"> <li>Your Bluetooth mobile device is not paired with HEOS device. Re-pair the HEOS device to the mobile device.</li> </ul>	<u>25</u>
<ul style="list-style-type: none"> <li>The HEOS device is Wi-Fi mode or Aux-in mode etc. Pair and connect Bluetooth device to HEOS device.</li> </ul>	-
<ul style="list-style-type: none"> <li>The Bluetooth mobile device is connected to another audio device. Make sure your Bluetooth device is connected to HEOS device.</li> </ul>	-
<ul style="list-style-type: none"> <li>The volume on Bluetooth mobile device is too low. Check the volume on the Bluetooth mobile device. Check the volume on the HEOS device.</li> </ul>	-



## My HEOS device turns off and the status LED flashes in red

Solution	Refer to Page
<ul style="list-style-type: none"><li>• The protection circuit has been activated due to a rise in temperature within your HEOS device. Turn the power off, wait about an hour until this device cools down sufficiently, and then turn the power on again.</li></ul>	–
<ul style="list-style-type: none"><li>• Check the speaker connections. The protection circuit may have been activated because speaker cable core wires came in contact with each other or a core wire was disconnected from the connector and came in contact with the rear panel of this device. After unplugging the power cord, take corrective action such as firmly re-twisting the core wire or taking care of the connector, and then reconnect the wire.</li></ul>	<u>13</u>



## Music cuts out or delays sometimes

Solution	Refer to Page
<ul style="list-style-type: none"> <li>• Make sure your Internet connection is operating correctly. If you are sharing your network with other users or devices, they may be using most of your bandwidth (especially if they are streaming video).</li> </ul>	<u>6</u>
<ul style="list-style-type: none"> <li>• Make sure your HEOS devices are within range of your wireless network.</li> </ul>	<u>44</u>
<ul style="list-style-type: none"> <li>• Make sure your HEOS devices are not located near other electronic devices that could interfere with it's wireless connectivity (like microwave ovens, cordless phones, TVs, etc...).</li> </ul>	<u>44</u>

## I hear a delay when using the external input with my TV

Solution	Refer to Page
<ul style="list-style-type: none"> <li>• If you are connecting the External input with your cable or satellite box for enjoying TV audio through multiple HEOS devices, you may hear a delay between when you see someone speak and when you hear the audio. This is because the HEOS system must buffer the audio before it sends it out to the HEOS devices so that it arrives at all devices at the same time.</li> </ul>	—
<ul style="list-style-type: none"> <li>• You can avoid this delay by listening only to the device which is directly connected to the set top box.</li> </ul>	—



## I hear distortion when using the AUX input

Solution	Refer to Page
<ul style="list-style-type: none"> <li>The analog output signals from some sources can be fairly strong. If the input level of the source device is turned up high, it could overload the inputs of the HEOS device. This is unlikely to cause damage, but can cause distorted sound. Initially, set the volume of the source to a medium – low level, then turn it up as needed. If you hear distortion, turn down the device's volume control.</li> </ul>	—

## Connecting to a WPS network

Solution	Refer to Page
<p>If your wireless router support WPS (Wi-Fi Protected Setup™) your HEOS wireless device can optionally connect to your network using the “Push Button” method by following these steps:</p> <p>Wi-Fi Protected Setup™ is trademarks of Wi-Fi Alliance.</p> <ol style="list-style-type: none"> <li>Press the WPS button on your router.</li> <li>Within 2 minutes, press and hold the Connect button on the rear panel of the HEOS device for 3 seconds.</li> <li>The LED on the front of the device will flash green for several seconds as it connects to your WPS router.</li> <li>When the connection is complete, the LED on the front of the device will turn solid blue.</li> </ol>	6



## Resetting your HEOS device

Solution	Refer to Page
<p>Resetting your HEOS device will clear out the wireless network info, EQ, and name but retain it's current software. You will have to use Settings - Add Device to reconnect the HEOS device to your home network before it can be used.</p> <p>To reset your HEOS device, press and hold the Connect and Bluetooth buttons located on the back of the HEOS device for 5 seconds until the front LED begins to flash amber.</p>	-

## Restoring the HEOS device to factory defaults

Solution	Refer to Page
<p>Restoring the HEOS device to its factory defaults will clear all of the settings and restore the original software which was installed at the factory.</p> <p><b>Caution</b></p> <ul style="list-style-type: none"> <li>All settings will be erased and the software will likely be downgraded!</li> </ul> <p>To restore your HEOS device to the factory defaults, unplug the power cable from the power outlet. Press and hold the Bluetooth button located on the back of the HEOS device, reconnect the power cable, and hold it in until the front LED begins to flash amber.</p>	-

\* For further information, please visit <http://www.HEOSbyDenon.com>



## Contact Denon

**For U.S. & Canada only:**

If you need further assistance with your HEOS product, please contact HEOS by Denon Customer Support Services below:

Website: [www.HEOSbyDenon.com/Support](http://www.HEOSbyDenon.com/Support)

Email: [Support@HEOSbyDenon.com](mailto:Support@HEOSbyDenon.com)

Live Chat: [www.HEOSbyDenon.com/LiveChat](http://www.HEOSbyDenon.com/LiveChat)

Telephone: Toll Free (855) 499 2820







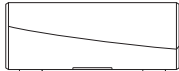

(M-F 10:00AM to 10:00PM EST / Sat 12:00PM to 8:00PM EST)

**For the other region:**

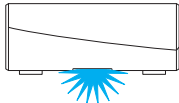
If you need additional help in solving problems, please contact Denon customer service in your area or visit <http://www.HEOSbyDenon.com>

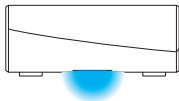

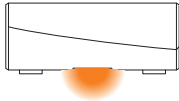
## Status LED table

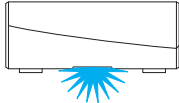
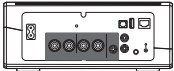

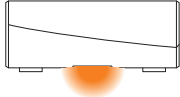
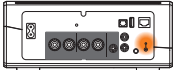
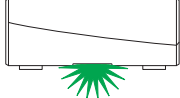
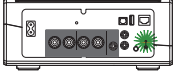
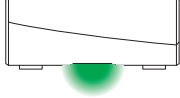
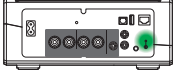
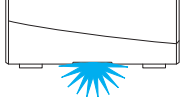
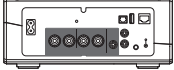

Device Operation	Description	Front LED Action	Rear LED Action
Off	No AC power or Deep Standby	 (off)	 (off)
Plug in	Booting	 (blink)	 (off)
On	Ready-Configured and connected to your network	 (solid)	 (off)
On	Not Connected to your network	 (solid)	 (solid)
Change Network	Connecting to your network	 (blink)	 (off)



Device Operation	Description	Front LED Action	Rear LED Action
Setup	Not connected	 (solid)	 (solid)
	Connect button was pressed	 (blink)	 (blink)
	Cable connection is OK	 (solid)	 (solid)
	Connecting to your network	 (blink)	 (off)

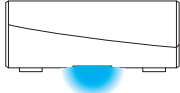
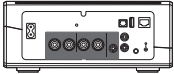
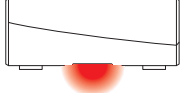

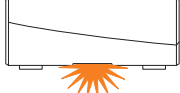
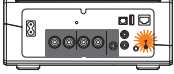
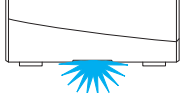
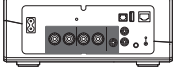
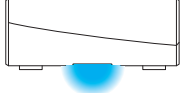



Device Operation	Description	Front LED Action	Rear LED Action
Setup	Configured and connected to your network	 (solid)	 (off)
	Error	 (solid)	 (solid)
Update	Updating	 (blink)	 (blink)
	Rebooting	 (blink)	 (off)
	Ready-Configured and connected to your network	 (solid)	 (off)

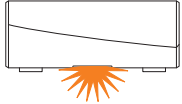
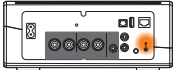
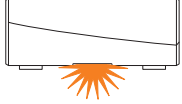
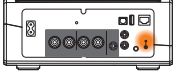
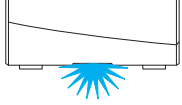
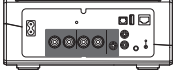
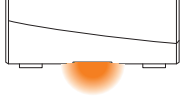
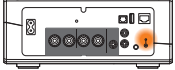



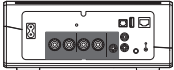

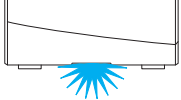
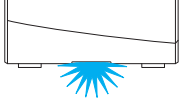
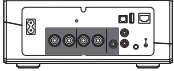

Device Operation	Description	Front LED Action	Rear LED Action
Reset	Soft reset - Clear user settings	 (fast blink)	 (solid)
	Hard reset - Factory restore	 (blink)	 (solid)
	Rebooting	 (blink)	 (off)
	Ready-Not Configured	 (solid)	 (solid)

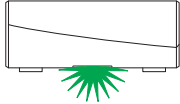
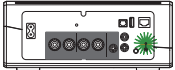
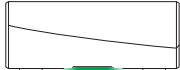
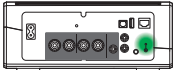
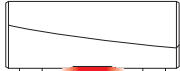

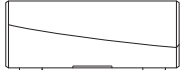

Device Operation	Description	Front LED Action	Rear LED Action
Errors	Firmware Error	 (slow blink (NOT fade))	 (off)
	Hardware Error	 (fast blink)	 (off)
	Network Error	 (solid)	 (solid)
Volume Change		 (quick blink)	 (off)
Mute		 (slow blink)	 (off)



Device Operation	Description	Front LED Action	Rear LED Action
WPS	a WPS session is active	 (fast blink)	 (fast blink)
	WPS connected	 (for 3 sec. solid)	 (solid)
	WPS time-out	 (for 3 sec. solid)	 (solid)
Power Management	Quick Start Mode	 (dimmed solid)	 (off)
	Deep Standby	 (off)	 (off)

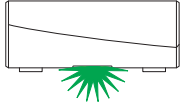
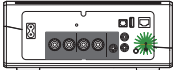
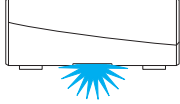
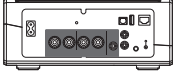
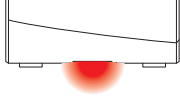

Device Operation	Description	Front LED Action	Rear LED Action
Bluetooth	Bluetooth pairing is active	 (two blinks)	 (two blinks)
	Connected (No Network)	 (one blink)	 (off)
	Bluetooth pairing is failed	 (for 3sec. solid)	 (for 3sec. solid)



## Supported file types and codecs

Frequency	Sample Rate	File Extension	Codec	Bit Rates
32/44.1/48 88.2/96/176.4 192 kHz	16/24 bit	wav	PCM	---
32 kHz 44.1 kHz 48 kHz	16 bit	mp3	MPEG-1 Audio Layer 3 CBR/VBR	32 - 320 kbps
32 kHz 44.1 kHz 48 kHz	16 bit	m4a aac	AAC-LC	48 - 320 kbps
32 kHz 44.1 kHz 48 kHz	16 bit	wma	wma9 CBR	CBR:48 - 192 kbps
44.1/48 88.2/96/176.4 192 kHz	16/24 bit	flac	flac	---
44.1/48 88.2/96/176.4 192 kHz	16/24 bit	m4a	ALAC	---

### NOTE

- Files protected by DRM such as Apple's Fairplay DRM, are not supported.
- The ALAC decoder is distributed under the Apache License, Version 2.0 (<http://www.apache.org/licenses/LICENSE-2.0>)

## Supported audio formats (Optical)

2-channel Linear PCM:2-channel, 32 kHz – 192 kHz, 16/20/24 bit



# Specifications

---

## ■ Audio section

<b>Power amplifier Rated output:</b>	2-channel driving 100 W+100 W (6 $\Omega$ /ohms, 1 kHz, T.H.D. 0.7 %)
<b>Output connectors:</b>	4 – 16 $\Omega$ /ohms
<b>THD+N:</b>	ANALOG IN: 0.5 % (1 kHz)
<b>S/N ratio (10 W, 6 <math>\Omega</math>/ohms, IHF-A):</b>	ANALOG IN: 86 dB (IHF-A weighted)
<b>Frequency response:</b>	10 Hz to 40 kHz: +1, -3 dB

## ■ Wireless LAN section

<b>Network type:</b>	Conforming to IEEE 802.11a/b/g/n/ac
<b>Used frequency range:</b>	2.4 GHz, 5 GHz

## ■ General

<b>Operating temperature:</b>	41 °F - 95 °F (5 °C - 35 °C)
<b>Power supply:</b>	AC 120 V, 60 Hz (for North America) AC 220 - 240 V, 50/60 Hz (for Europe)
<b>Power consumption:</b>	60 W
<b>Power consumption in Quick Start Mode: *</b>	4.1 W (Wi-Fi) 3.5 W (Ethernet) 4.2 W (USB) 3.8 W (Bluetooth)
<b>Power consumption in Deep Standby Mode: *</b>	0.3 W

\*Cable to AUX IN must be disconnected to enter Quick Start Mode and Deep Standby Mode.



## ■ Dimensions (Unit : in. (mm))

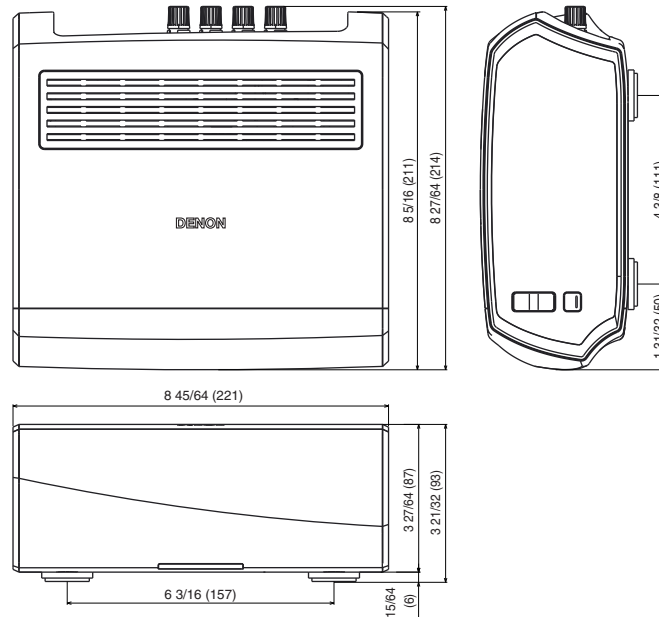

## ■ Weight : 6 lbs 3 oz (2.8 kg)

For the purpose of improvement, the specifications and design are subject to change without notice.





# Information

## Trademarks



Google Play and the Google Play logo are trademarks of Google LLC.



Apple, the Apple logo, iPad, iPhone, and iPod touch are trademarks of Apple Inc., registered in the U.S. and other countries. App Store is a service mark of Apple Inc.



Amazon, Kindle, Echo, Alexa, Dash, Fire and all related logos are trademarks of Amazon.com, Inc. or its affiliates.



The Bluetooth® word mark and logos are registered trademarks owned by Bluetooth SIG, Inc. and any use of such marks by D&M Holdings Inc. is under license. Other trademarks and trade names are those of their respective owners.



**DENON®**

[HEOSbyDenon.com](http://HEOSbyDenon.com)

3520 10430 00ADE

Copyright © 2016 D&M Holdings Inc. All Rights Reserved.