

DENON[®]

DHT-S216

SOUND BAR

Owner's Manual



Accessories	4
Inserting the batteries	5
Operating range of the remote control unit	5
Features	6
Part names and functions	7
Sound bar	7
Remote control unit	11

Connections

Positioning	13
Positioning the sound bar	13
Connecting a TV	15
Connection 1: TV equipped with an HDMI connector and compatible with the ARC (Audio Return Channel)	16
Connection 2: TV equipped with an HDMI connector and incompatible with the ARC / TV equipped with an optical digital connector	17
Connection 3: TV equipped with an HDMI connector and incompatible with the ARC / TV equipped with an analog connector	18
Connecting the subwoofer	19
Connecting an HDMI device	20
Connecting the power cords	21

Playback

Enjoying TV, movies and music	22
Adjusting the volume	23
Adjusting the subwoofer volume	23
Turning off the sound temporarily	23
Listening to music on a Bluetooth device	24
Pairing a Bluetooth device for the first time	24
Pairing with other Bluetooth devices	25
Listening to music with a paired Bluetooth device	25

Settings

Settings	26
Selecting a listening mode	26
Setting the quick start mode	27
Switching automatically to the standby mode (auto-standby function)	28
Operating this unit using the remote control of a TV	29



Tips

Troubleshooting	31
Power does not turn on / Power is turned off	32
Power takes a long time to turn on	32
Operations cannot be performed through the remote control unit	32
No sound comes out	33
Bluetooth playback does not work	34
The HDMI Control function does not work	34
Resetting factory settings	35

Appendix

About HDMI	36
Trademark information	37
Specifications	38











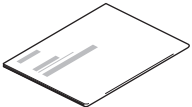

Thank you for purchasing this Denon product.

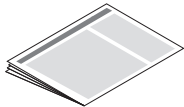
To ensure proper operation, please read this owner's manual carefully before using the product.

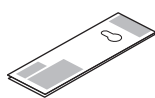
After reading this manual, be sure to keep it for future reference.

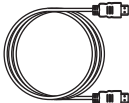
Accessories

Check that the following parts are supplied with the product.

 Quick Start Guide	 Safety Instructions	 Cautions on Using Batteries	 Warranty	 Wall mount template
 Power cord	 HDMI cable	 Optical digital cable	 Wall mount spacers	 Remote control unit (RC-1236)
 R03/AAA battery				



Inserting the batteries

- 1 Slide the rear cover off the remote control unit in the arrow direction.

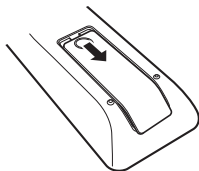

- 2 Insert 1 battery into the battery compartment as indicated.

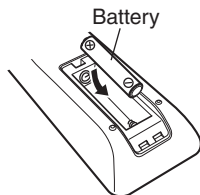

- 3 Put the rear cover back on.

NOTE

- Remove the batteries from the remote control unit if it will not be in use for long periods.
- If the battery fluid should leak, carefully wipe the fluid off the inside of the battery compartment and insert new batteries.

Operating range of the remote control unit

Point the remote control unit at the remote sensor when operating it.

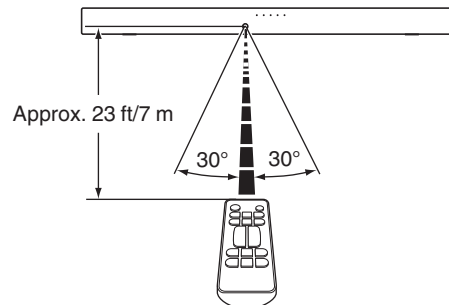

Features

- **Theater-quality Sound**

Immerse yourself in Denon theater-quality sound with the Denon DHT-S216 sound bar. With two built-in down firing subwoofers, Dual mid-range drivers, detailed crisp tweeters, elevate your sound from a low-profile design.

- **Performance-Tuned Surround Sound**

With Dolby Digital decoding, create incredible room-filling surround sound that takes your entertainment to the next level. Also, with DTS Virtual:X technology, the Denon DHT-S216 provides immersive audio with height channels, creating a virtual height effect for your favorite entertainment.

- **Universal Compatibility with HDMI support ARC (Audio Return Channel)**

Send audio from apps built into your Smart TV and other sources via the ARC (Audio Return Channel) on the DHT-S216 and a single HDMI cable (included). Also enables control of the Denon DHT-S216 via your TV's remote control.

- **Wireless Music Streaming**

Easily enjoy your favorite music by streaming directly from your smart device to your sound bar with Bluetooth.

- **Denon Dialog Enhancer**

Never miss a word of your favorite TV show or movie. Denon Dialog Enhancer improves dialog intelligibility — ideal for movies and TV shows. Turn up the dialog without having to adjust overall volume.



Part names and functions

Sound bar

■ Top panel

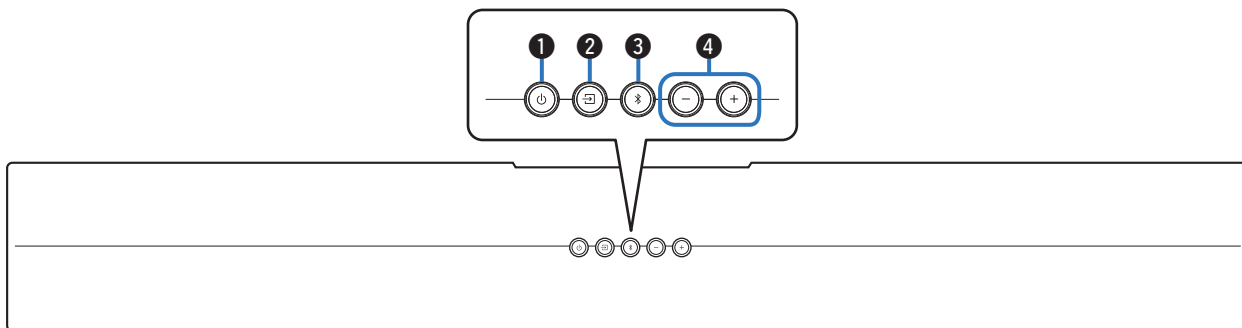

❶ Power operation button (⏻)

Turns the sound bar power on/off (standby). (👉 p. 22)

❷ Input source button (📺)

This selects the input source. (👉 p. 22)

Switches the input source each time the button is pressed.

❸ Bluetooth button (📶)

- Switches the input source to “Bluetooth”. (👉 p. 24)
- Used to pair with Bluetooth devices. (👉 p. 24)

❹ Volume buttons (+, -)

These adjust the volume level. (👉 p. 23)



■ Front panel

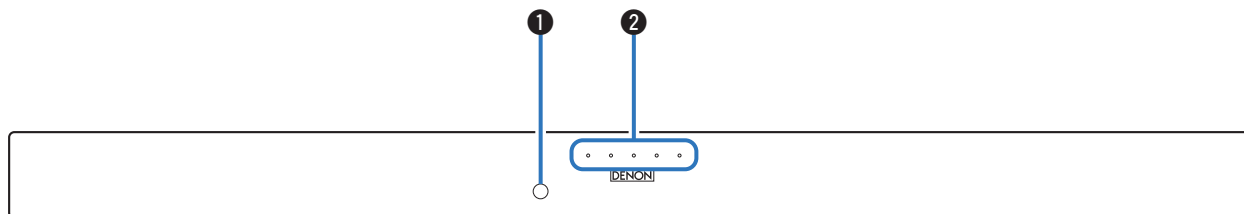

① Remote control sensor

This receives signals from the remote control unit. (👉 p. 5)

② Status LED

The status, such as for the power, input source, or audio format, is displayed. (👉 p. 9)



■ Status LED

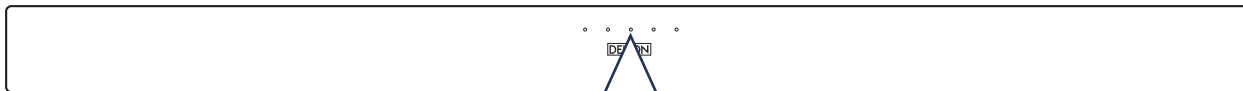

Power	Off (Standby)	<input type="radio"/>	<input type="radio"/>	<input type="radio"/>	<input type="radio"/>	<input type="radio"/>
	On	<input checked="" type="radio"/>	<input checked="" type="radio"/>	<input checked="" type="radio"/>	<input checked="" type="radio"/>	<input checked="" type="radio"/>
Input source	HDMI	<input type="radio"/>	<input type="radio"/>	<input type="radio"/>	<input type="radio"/>	<input type="radio"/>
	TV (ARC)	<input type="radio"/>	<input checked="" type="radio"/>	<input type="radio"/>	<input type="radio"/>	<input type="radio"/>
	TV (OPT)	<input type="radio"/>	<input checked="" type="radio"/>	<input checked="" type="radio"/>	<input type="radio"/>	<input type="radio"/>
	ANALOG	<input type="radio"/>	<input checked="" type="radio"/>	<input checked="" type="radio"/>	<input checked="" type="radio"/>	<input type="radio"/>
	Bluetooth	<input type="radio"/>	<input type="radio"/>	<input type="radio"/>	<input checked="" type="radio"/>	<input type="radio"/>
Audio format [Ex.] Input source: TV (ARC)	Dolby	<input checked="" type="radio"/>	<input checked="" type="radio"/>	<input type="radio"/>	<input type="radio"/>	<input type="radio"/>
	DTS	<input checked="" type="radio"/>	<input checked="" type="radio"/>	<input type="radio"/>	<input type="radio"/>	<input type="radio"/>



■ Rear panel

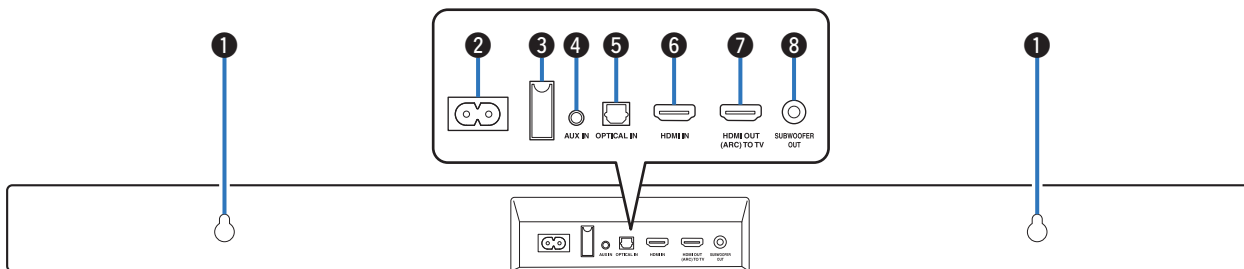

① Wall hook hole

Used to mount the sound bar on a wall. (👉 p. 14)

② AC inlet

Used to connect the power cord. (👉 p. 21)

③ USB port

Service terminal. This port does not support playback of music from USB flash drives.

④ AUX audio input connector (AUX IN)

Use a commercially available 3.5 mm stereo audio cable to connect an audio device. (👉 p. 18)

⑤ Optical digital input connector (OPTICAL IN)

Use the included optical digital cable to connect a TV with an optical digital connector. (👉 p. 17)

⑥ HDMI input connector (HDMI IN)

Use a commercially available HDMI cable to connect an HDMI compatible device. (👉 p. 20)

⑦ HDMI output connector (HDMI OUT (ARC) TO TV)

Use the included HDMI cable to connect an ARC function-compatible TV. (👉 p. 16)

⑧ Subwoofer output connector (SUBWOOFER OUT)

Use a commercially available subwoofer cable to connect a subwoofer with a built-in amplifier. (👉 p. 19)



Remote control unit

This section mainly explains remote control operations.

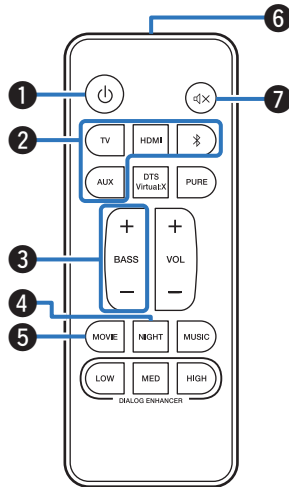

1 Power button (⏻)

Turns the sound bar power on/off. (👉 p. 22)

2 Input source buttons (TV, HDMI, Ƶ, AUX)

This selects the input source. (👉 p. 22)

3 Button to adjust subwoofer (BASS +, -)

Adjusts the volume level for the subwoofer. (👉 p. 23)

4 Night mode button (NIGHT)

Compresses the dynamic range (difference between loud and soft sounds) to make audio easier to hear at low volumes. (👉 p. 26)

5 Movie mode button (MOVIE)

Enjoy movie theater-like surround sound. (👉 p. 26)

6 Remote control signal transmitter

This transmits signals from the remote control unit. (👉 p. 5)

7 Mute button (🔇)

This mutes the output audio. Press again to unmute. (👉 p. 23)



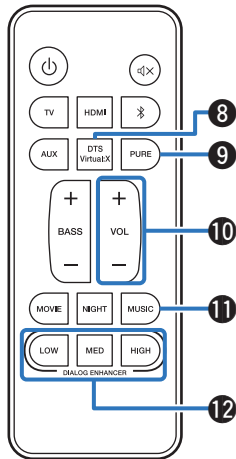

8 DTS Virtual:X button

This turns the DTS Virtual:X function on and off. (👉 p. 26)



- DTS Virtual:X function is disabled when listening mode is set to "PURE".

9 Pure mode button (PURE)

Enjoy high quality sound that is faithful to the original source. (👉 p. 26)

10 Volume buttons (VOL +, -)

These adjust the volume level. (👉 p. 23)

11 Music mode button (MUSIC)

Enjoy the natural and realistic surround sound of a concert hall. (👉 p. 26)

12 Dialog enhancer buttons (DIALOG ENHANCER LOW, MED, HIGH)

Adjust the volume of dialog in movies, vocals in music, etc. so these can be heard more easily. (👉 p. 26)

Can be set to 3 levels. Set this to the desired value.



Positioning

Positioning the sound bar

Position the sound bar in front of your TV, etc., on a flat surface.

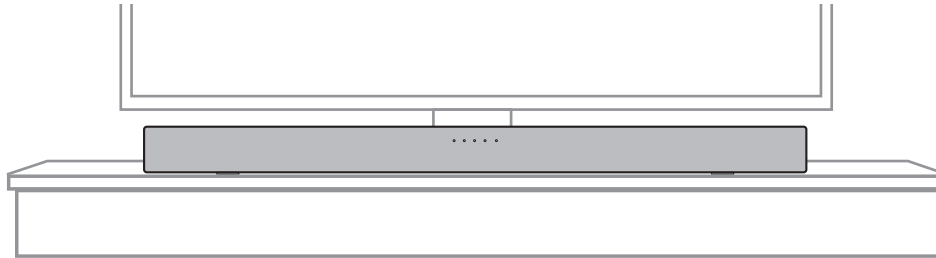

NOTE

- When positioning the sound bar in front of your TV, make sure the sound bar does not obstruct the TV's remote control light sensor, etc.



■ When hanging the sound bar on a wall

The sound bar has a wall hook hole to hang it on a wall. When hanging it on a wall, position it in a flat, vertical position.

To ensure safety, request a contractor perform the mounting work when mounting onto a wall.

NOTE

- In order to use the unit safely, do not place items on or hang items from the unit.
- Be sure to fix connection cables to the wall to ensure that cannot be pulled or tripped over causing this unit to fall. Check that the unit is mounted safely after the mounting work is complete.
- Also, periodically check the safety of this unit and whether there is a possibility that the unit may fall.
- Denon cannot accept any responsibility for damage, injury or accidents caused by problems with the mounting location or mounting method.

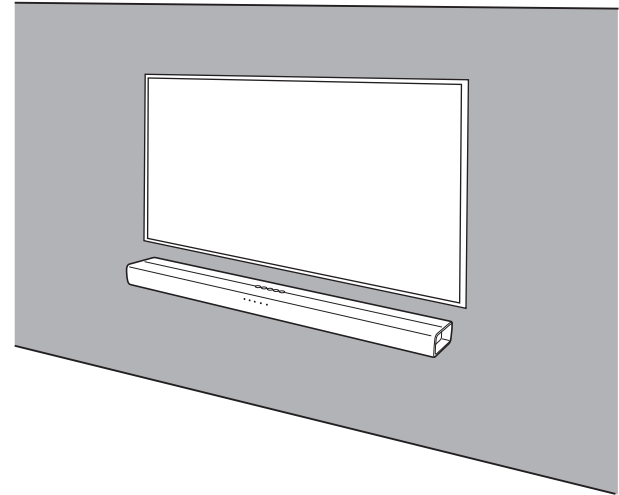

- When hanging it on a wall, use the included wall mount template.

[How to use the wall mount template]

- ① Affix the template to the location you would like to mount the sound bar.
- ② Screw in the wall mount screws by following the template.
Consult a construction professional about the proper wall mount screws for the material and strength of your wall.
- ③ Remove the template from the wall.
- ④ Mount the included wall mount spacer on the spine of the sound bar.
Mounting the wall mount spacer creates a space for cords to pass through between the sound bar and the wall.
- ⑤ Mount the sound bar on the wall.



Connecting a TV

How to connect a TV depends on the connectors and functions equipped on the TV.



- Enable the TV's HDMI control function when using an HDMI cable to connect this device to your TV. (See the TV owner's manual for details.)
- Turn off the TV's speaker or minimize the volume when using this device.
- HDMI cable connection is recommended, but connection can be performed without an HDMI cable.

NOTE

- Make sure all devices are off when connecting.
- Do not plug device power cords into an outlet until all devices have been connected.



Connection 1: TV equipped with an HDMI connector and compatible with the ARC (Audio Return Channel)

Use the included HDMI cable to connect this device to an ARC function-compatible TV.

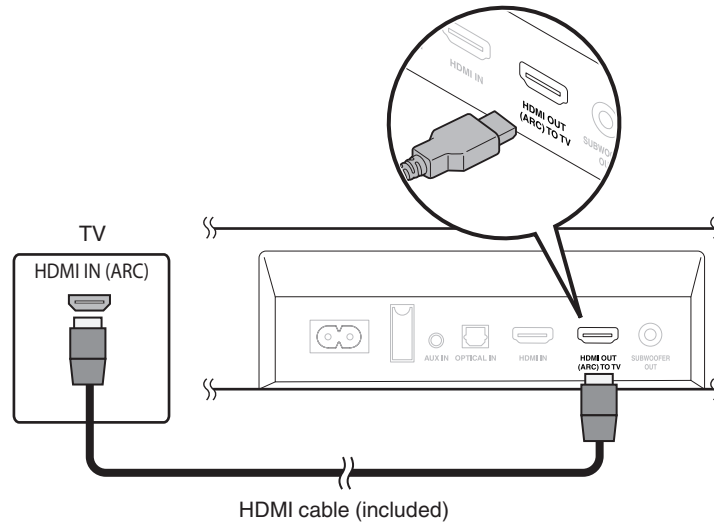

- The TV also needs to be compatible with the ARC function.



Connection 2: TV equipped with an HDMI connector and incompatible with the ARC / TV equipped with an optical digital connector

Use the included HDMI and optical digital cables to connect this device to your TV.

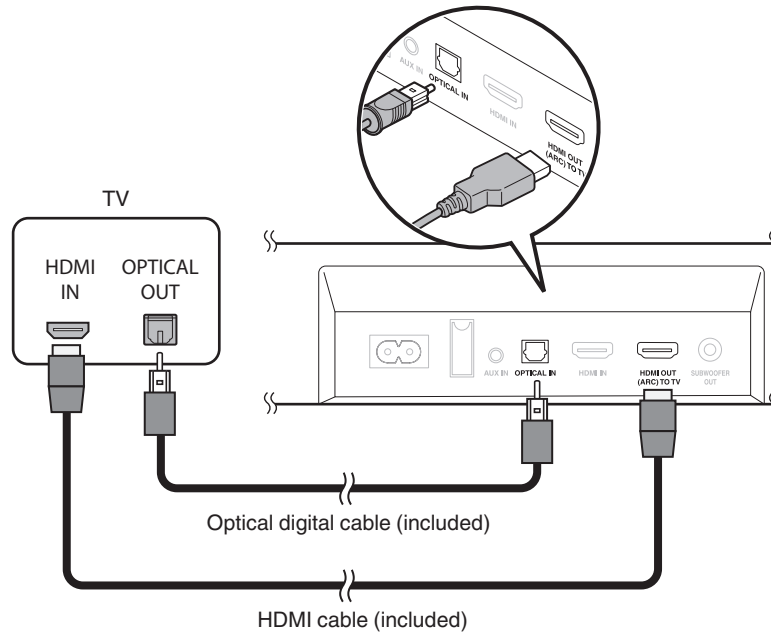

- Line up the optical digital cable with the shape of the terminal to insert.



Connection 3: TV equipped with an HDMI connector and incompatible with the ARC / TV equipped with an analog connector

Use the included HDMI cable and a commercially available 3.5 mm stereo audio cable to connect this device to your TV.

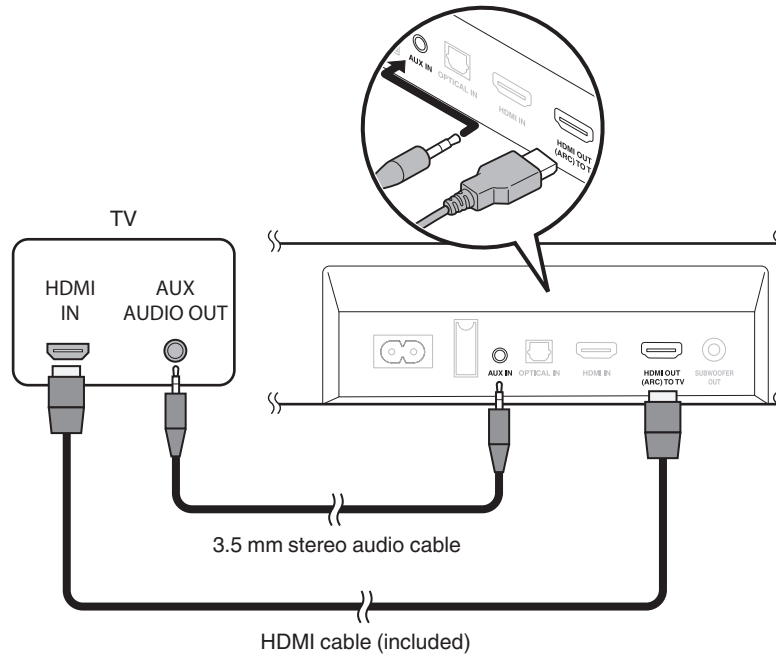

Connecting the subwoofer

While this device contains a subwoofer of its own, you can achieve even deeper bass by connecting a subwoofer with a built-in amplifier. Use a commercially available subwoofer cable to connect a subwoofer with a built-in amplifier to this unit.

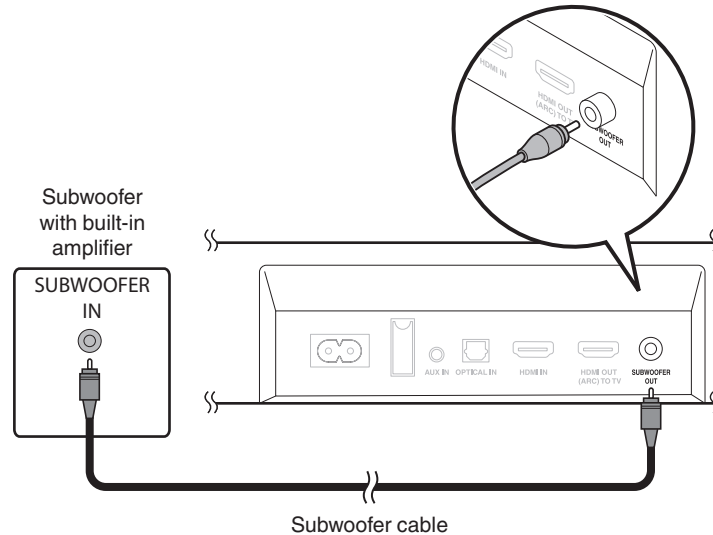

Connecting an HDMI device

Use a commercially available HDMI cable to connect a Blu-ray disc player, game device or similar device to this unit.

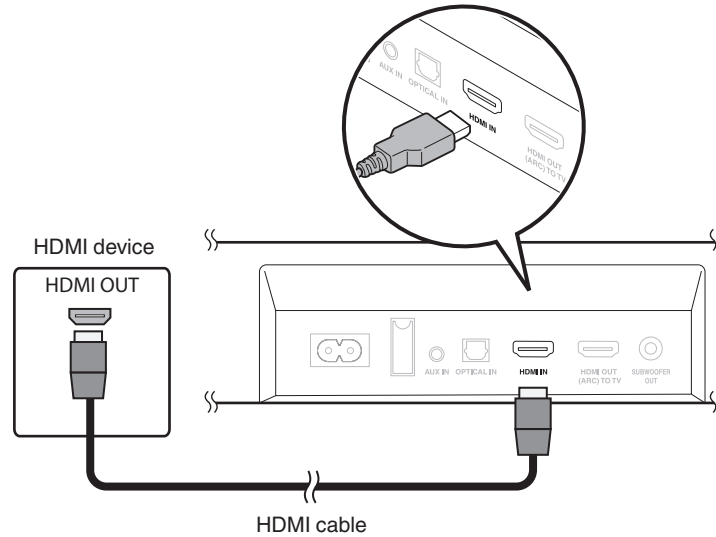

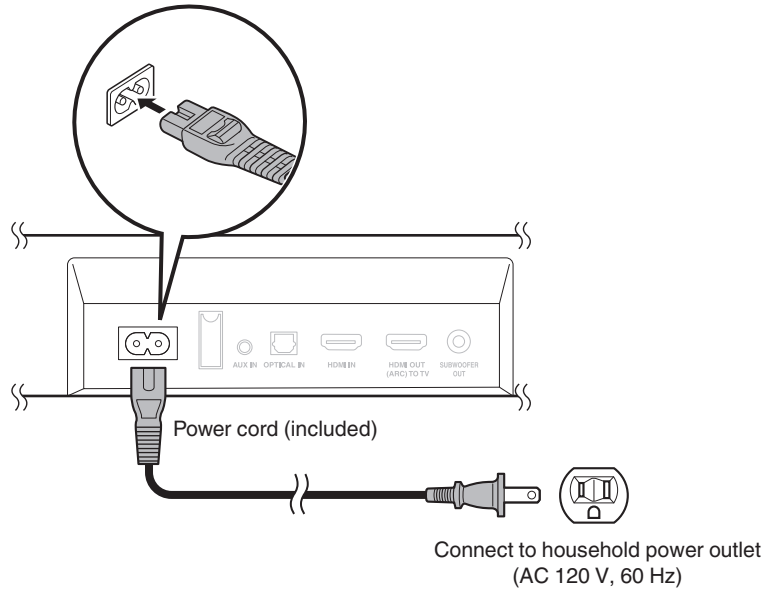

Connecting the power cords

After completing all the connections, insert the power plug into the power outlet.

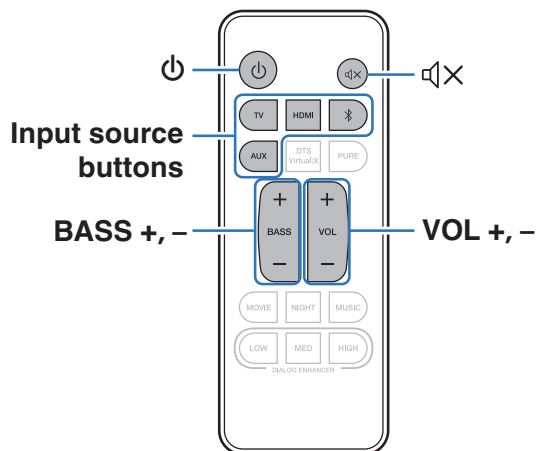

Enjoying TV, movies and music



- 1 Turn on the power of the TV and connected devices.
- 2 Press  to turn on power to the unit.
- 3 Press the input source button to change the input source.
- 4 Play the device connected to this unit.
For details, see the relevant device manual.



- Connect an HDMI control-compatible TV and this device via HDMI and enable the HDMI control to enable linked control from either device. (🔗 p. 36)



Adjusting the volume

1 Use VOL + or VOL – to adjust the volume.

When the button is pressed, the status display LED lights up to match the current volume.

- The status display LED blinks each time the button is pressed, and the number of flashing LEDs increases or decreases to match the volume.
- When the volume reaches the maximum or minimum, the status display LED blinks three times.



- When the power is turned on, the unit starts with the volume level that was set before being placed on standby. However, if the volume was previously set to high, it starts with the volume setting lowered to a certain level.

Adjusting the subwoofer volume

1 Use BASS + or BASS – to adjust the subwoofer volume.

When the button is pressed, the status display LED lights up to match the current subwoofer volume.

- The status display LED blinks each time the button is pressed, and the number of flashing LEDs increases or decreases to match the subwoofer volume.
- When the subwoofer volume reaches the maximum or minimum, the status display LED blinks three times.

Turning off the sound temporarily

1 Press .

All status display LEDs blink.



- To cancel, press  again.



Listening to music on a Bluetooth device

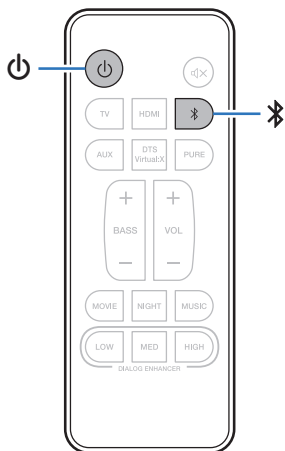

Music files stored on Bluetooth devices such as smartphones, digital music players, etc. can be enjoyed on this unit by pairing and connecting this unit with the Bluetooth device.



Pairing a Bluetooth device for the first time



Pair a Bluetooth device with this unit.

Once the Bluetooth device has been paired, it does not need to be paired again.

- 1 Press  to turn on power to the unit.**
- 2 Press  to switch the input source to “Bluetooth”.**
Automatically switches to pairing mode the first time it is used.
The status display LED blinks in blue when this unit is in pairing mode.
- 3 Activate the Bluetooth settings on your Bluetooth device.**
- 4 Select “DHT-S216” from the list of devices displayed on the screen of the Bluetooth device.**
The status display LED lights up in blue and this device and the Bluetooth device are paired.





Pairing with other Bluetooth devices

- 1 Press  to turn on power to the unit.
- 2 Press  to switch the input source to “Bluetooth”.
- 3 Activate the Bluetooth settings on your Bluetooth device.
- 4 Push  on this device until the status display LED blinks in blue.
- 5 **Select “DHT-S216” from the list of devices displayed on the screen of the Bluetooth device.**
The status display LED lights up in blue and this device and the Bluetooth device are paired.



- This unit can be paired with a maximum of 8 Bluetooth devices. When a 9th Bluetooth device is paired, it will be registered in place of the oldest registered device.

Listening to music with a paired Bluetooth device

- 1 Press  to turn on power to the unit.
- 2 Press  to switch the input source to “Bluetooth”.
- 3 **Activate the Bluetooth settings on your Bluetooth device.**
The status display LED lights up in blue and connects to the last Bluetooth device connected. If the connection is cut, perform connection again.
- 4 **Play music using any app on your Bluetooth device.**



Settings

Perform the below operations and settings as needed.

Selecting a listening mode

1 Press the listening mode button to select a listening mode.

When the button is pressed, the rightmost status display LED flashes and the listening mode changes.

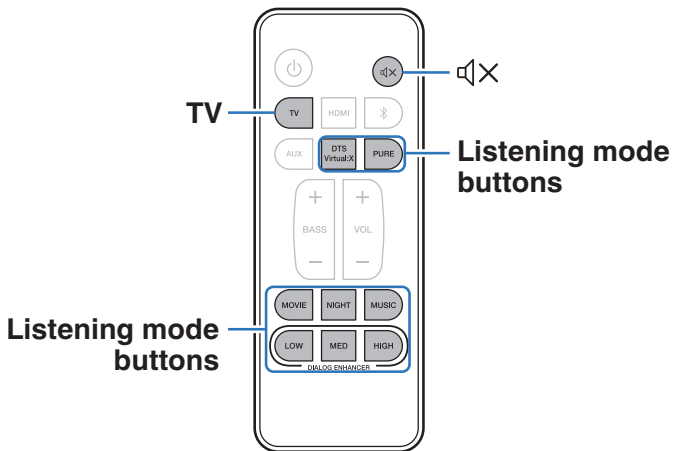

MOVIE (Default):	Enjoy movie theater-like surround sound.
MUSIC:	Enjoy the natural and realistic surround sound of a concert hall.
NIGHT:	Compresses the dynamic range (difference between loud and soft sounds) to make audio easier to hear at low volumes.
DIALOG ENHANCER LOW / MED / HIGH:	Adjust the volume of dialog in movies, vocals in music, etc. so these can be heard more easily. Can be set to 3 levels. Set this to the desired value.
PURE:	Enjoy sound that is faithful to the original source.



2 Press DTS Virtual: X to add surround sound with a sense of height to your current listening mode.

When the button is pressed, the rightmost status display LED lights blue.

DTS Virtual:X:	Enjoy virtual 3D surround sound with height perception in addition to sound from the front, left, right and back.
-----------------------	---



- DTS Virtual:X function is disabled when listening mode is set to "PURE".
- Set the listening mode to "MOVIE" or "MUSIC" before using the DTS Virtual:X function.

Setting the quick start mode

When set to Quick Start mode, the following two functions are enabled in standby mode.

■ Bluetooth standby function

The sound bar can be connected to from a Bluetooth device even when in standby. Connecting turns the sound bar on.

■ HDMI pass through function

HDMI signals received by the sound bar are output to the television, even when in standby mode.

1 Press and hold TV for 5 seconds or more until the status display LEDs blink as indicated below.

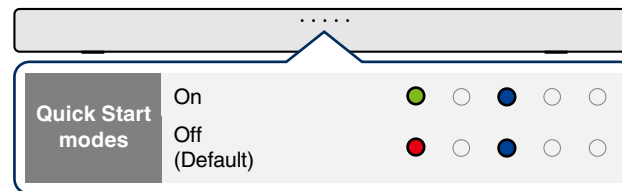

- This unit consumes more power when the Quick Start modes is on.



Switching automatically to the standby mode (auto-standby function)

Toggle the auto-standby function on and off.

If no operations have been performed for 15 minutes or more and audio is not being output, this device automatically switches to standby.

1 Press and hold NIGHT for 5 seconds or more.

The status display LEDs blink as shown below.

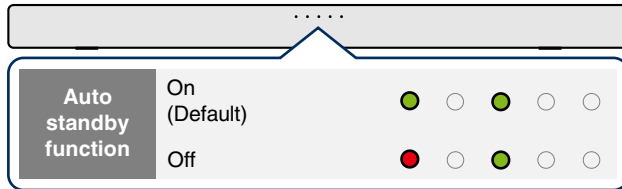

Operating this unit using the remote control of a TV

There are two ways to operate this unit using the remote control of a TV.

• HDMI control function

Connect this unit to a TV that supports the HDMI control function with an HDMI cable and enable the HDMI control setting on the TV to perform basic operations on this unit (changing the input source, turning the power on and off, adjusting the volume) with the remote control of the TV.

Refer to “HDMI control function” for more information about the HDMI control function. (📖 p. 36)

• Remote control learning function

If your TV does not support the HDMI control function, use this unit's remote control learning function. This enables you to operate this unit with the remote control of a TV. (“Using the remote control learning function” (📖 p. 29))

■ Using the remote control learning function

1 Press and hold the main unit's for 3 seconds or more.

Among the LEDs on the status display, one white LED light moves back and forth from left to right and indicates that the remote control learning mode has started.

2 Point the remote control of this unit at the remote sensor of this unit and press the remote control button to be learned (e.g. VOL +) once.

All status display LEDs blink in white.

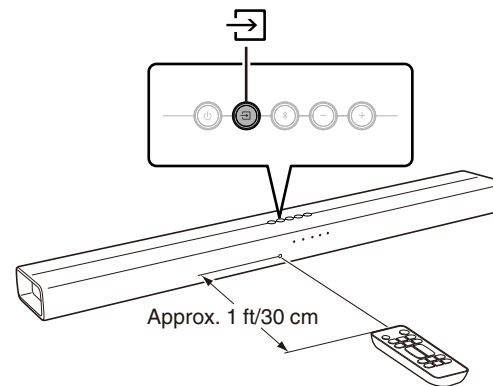

3 Point the remote control of the TV at the remote control sensor of this unit and press the remote control button to be learned (e.g. the button to increase the volume) once.

If learning is successful, the rightmost status display LED blinks in blue three times.

If learning is unsuccessful, the rightmost status display LED blinks in red three times. Repeat steps 2 and 3 if this happens.



- When the status LEDs blink in white again, press the TV remote control button (e.g. the button to increase the volume) once more.

4 To learn a new function, repeat steps 2 and 3 with the next function.

5 Press and hold the main unit's for 3 seconds or more.

The rightmost status display LED blinks white three times and indicates that the remote control learning mode is completed.

6 Confirm that the operation (e.g. increasing the volume) can be performed on this unit with the TV remote control.



- To delete all learned data, press and hold  on the sound bar for 10 seconds until the rightmost status display LED blinks white five times.
- Operations cannot be performed with the remote control learning function during the standby that is set when the Bluetooth standby function or HDMI pass through function is off.
- Other operations cannot be performed when in remote control learning mode.
- Remote control learning may not be possible depending on the type of TV remote control.
- The power button of TVs learned with the remote control learning function cannot be operated when Quick Start mode is off.



Troubleshooting

If a problem should arise, first check the following:

1. **Are the connections correct?**
2. **Is the set being operated as described in the owner's manual?**
3. **Are the other devices operating properly?**

If this unit does not operate properly, check the corresponding symptoms in this section.

If the symptoms do not match any of those described here, consult your dealer as it could be due to a fault in this unit. In this case, disconnect the power immediately and contact the store where you purchased this unit.



Power does not turn on / Power is turned off

Power does not turn on.

- Check whether the power plug is correctly inserted into the power outlet. (👉 p. 21)
- If the power of this unit cannot be turned on with the HDMI control function of the TV, press the ⏻ button to turn on the power of this unit. (👉 p. 36)
- If the power cannot be turned on through a Bluetooth connection, turn on the Bluetooth standby function. (👉 p. 27)

Power automatically turns off.

- If no operations have been performed for 15 minutes or more and audio is not being output, this device automatically switches to standby. (Auto standby function) Turn the power of this unit off and then on again. To disable the auto standby function, set the auto standby function to off. (👉 p. 28)

Power takes a long time to turn on

Power takes a long time to turn on.

- When you use the power-linked function of the HDMI control function, you can turn on Quick Start mode to turn on this unit quickly. (👉 p. 27)

Operations cannot be performed through the remote control unit

Operations cannot be performed through the remote control unit.

- Batteries are worn out. Replace with new batteries. (👉 p. 5)
- Operate the remote control unit within a distance of about 23 ft/7 m from this unit and at an angle of within 30°. (👉 p. 5)
- Remove any obstacle between this unit and the remote control unit.
- Insert the batteries in the proper direction, checking the ⊕ and ⊖ marks. (👉 p. 5)
- The set's remote control sensor is exposed to strong light (direct sunlight, inverter type fluorescent bulb light, etc.). Move the set to a place in which the remote control sensor will not be exposed to strong light.



No sound comes out

No sound comes out.

- Check the connections for all devices. (👉 p. 15)
- Insert connection cables all the way in.
- Check that input connectors and output connectors are not reversely connected.
- Check cables for damage.
- Check that a proper input source is selected. (👉 p. 22)
- Adjust the volume. (👉 p. 23)
- Make sure volume is not muted. (👉 p. 23)



Bluetooth playback does not work

Cannot pair with a Bluetooth device.

- It may be that Bluetooth is not enabled on the Bluetooth device. See the owner's manual of the Bluetooth device to enable the Bluetooth function.
- This device may be paired with another Bluetooth device. Select this unit from the list of devices displayed on the screen of the Bluetooth device.
- Bring the Bluetooth device near to this unit.
- Turn the power of the Bluetooth device off and on again, and then try again.
- Only 1 Bluetooth device can be connected at a time.

The sound is cut off.

- Bring the Bluetooth device near to this unit.
- Remove obstructions between the Bluetooth device and this unit.
- To prevent electromagnetic interference, locate this unit away from microwave ovens, wireless LAN devices and other Bluetooth devices.
- Pair with the Bluetooth device again. (👉 p. 24)

The HDMI Control function does not work

The HDMI Control function does not work.

- You cannot operate devices that are not compatible with the HDMI Control function. In addition, depending on the connected device or the settings, the HDMI Control function may not work. In this case, operate the external device directly.
- Check that the HDMI Control function setting is enabled on all devices connected to this unit.





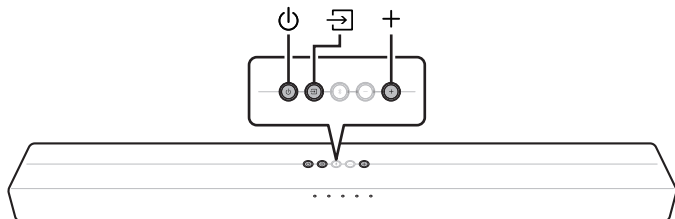

Resetting factory settings

Perform this procedure if the display is abnormal or if operations cannot be performed.

Various settings are reset to the factory default values. Make settings again.



- 1 Press  to turn on power to the unit.**
- 2 Press and hold the main unit's ,  and + at the same time for at least 5 seconds.**
The status display LED blinks in red three times.
- 3 Wait for around 10 seconds after the LED turns off and then press .**
All settings return to the factory settings after the sound bar is restarted.



About HDMI

This unit supports the following HDMI functions.

- **ARC (Audio Return Channel) function**

Enjoy movies, music, etc., on your TV simply by connecting an ARC function-compatible TV to this device via HDMI.

- **HDMI control function**

You can control the TV via this unit and vice versa by connecting a TV that supports the HDMI control function to this unit via HDMI and enabling the HDMI control function on the TV.

- Input source switching

If the TV is turned on, this device automatically powers on and switches the input source.

- Power off link

The TV power off operation is linked so this device also turns off.

- Volume adjustment

The volume of this unit can be adjusted using the TV remote control.

- Audio output destination switching

If this unit is turned on, TV audio is output from this unit. If this device is turned off, TV audio is output from the speakers of the TV.

NOTE

- Some functions may not operate depending on the connected TV. Check the owner's manual of each device for details beforehand.



Trademark information



The Bluetooth® word mark and logos are registered trademarks owned by the Bluetooth SIG, Inc. and any use of such marks by D&M Holdings Inc. is under license. Other trademarks and trade names are those of their respective owners.



Manufactured under license from Dolby Laboratories. Dolby, Dolby Audio, and the double-D symbol are trademarks of Dolby Laboratories.



For DTS patents, see <http://patents.dts.com>. Manufactured under license from DTS, Inc. DTS, the Symbol, DTS and the Symbol together, Digital Surround, Virtual:X, the DTS Digital Surround logo, and the DTS Virtual:X logo are registered trademarks or trademarks of DTS, Inc. in the United States and/or other countries. © DTS, Inc. All Rights Reserved.



The terms HDMI, HDMI High-Definition Multimedia Interface, and the HDMI Logo are trademarks or registered trademarks of HDMI Licensing Administrator, Inc.



Specifications

■ General

Operating temperature:	41 °F - 95 °F (5 °C - 35 °C)
Power supply:	AC 120 V, 60 Hz
Power consumption:	40 W
Power consumption in standby mode:	0.45 W
Power consumption in Quick Start modes:	5.0 W
Sampling frequency:	32 kHz, 44.1 kHz, 48 kHz
Supported audio formats:	Dolby Digital, DTS Digital Surround, Linear PCM



■ Bluetooth section

Communications system:	Bluetooth Version 4.2
Transmission power:	Power Class 2
Maximum communication range:	Approx. 32.8 ft/10 m in line of sight*
Used frequency range:	2.4 GHz band
Modulation scheme:	FHSS (Frequency-Hopping Spread Spectrum)
Supported profiles:	A2DP (Advanced Audio Distribution Profile) 1.3 AVRCP (Audio Video Remote Control Profile) 1.6
Corresponding codec:	SBC
Transmission range (A2DP):	20 Hz – 20,000 Hz

*The actual communication range varies depending on the influence of such factors as obstructions between devices, electromagnetic waves from microwave ovens, static electricity, cordless phones, reception sensitivity, antenna performance, operating system, application software etc.

For purposes of improvement, specifications and design are subject to change without notice.



■ Dimensions (Unit : in. (mm))

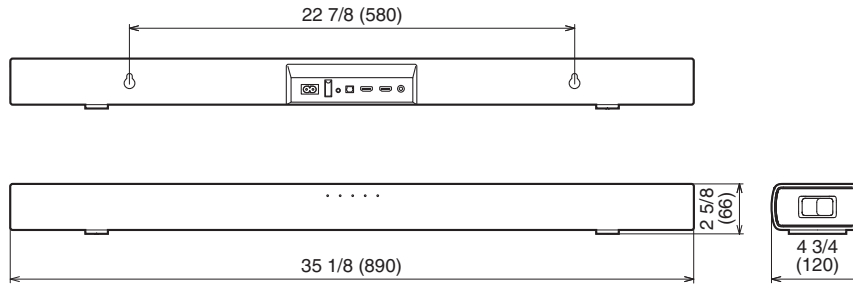

■ Weight : 7 lbs 11 oz (3.5 kg)



DENON®

3520 10719 00ADB

Copyright © 2019 D&M Holdings Inc. All Rights Reserved.