

DENON[®]

PMA-600NE

INTEGRATED AMPLIFIER

Owner's Manual

[Front panel](#)[Rear panel](#)[Remote control
unit](#)[Index](#)

Accessories	4
Inserting the batteries	5
Operating range of the remote control unit	5
Features	6
High quality sound	6
High performance	6
Part names and functions	7
Front panel	7
Rear panel	10
Remote control unit	12

Connections

Connecting speakers	17
Subwoofer connection	18
Speaker connection	18
Connecting a playback device	19
Connecting a recording device	20
Connecting to a device with digital audio output connectors	21
Connecting the power cord	22

Playback

Turning the power on	24
Switching the power to standby	24
Selecting the input source	25
Adjusting the volume	25
Turning off the sound temporarily (Muting)	25
Adjusting the tone	25
Playing CDs	26
Listening to music on a Bluetooth device	28
Connecting and playing back from a digital device (Coaxial/ Optical)	30
Recording	31

Settings

Setting the Auto Standby mode	32
--------------------------------------	-----------



Tips

Tips	34
Troubleshooting	35
Power does not turn on / Power is turned off	36
Operations cannot be performed through the remote control unit	37
No sound comes out	38
Desired sound does not come out	39
Sound is interrupted or noise occurs	40
Bluetooth cannot be played back	41
Audio from digital devices cannot be played back (Coaxial/ Optical)	42

Appendix





D/A converter	43
Playing back a Bluetooth device	43
Explanation of terms	44
Trademark information	45
Specifications	46
Index	50

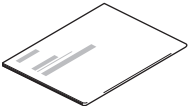
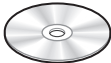

Thank you for purchasing this Denon product. To ensure proper operation, please read this owner's manual carefully before using the product. After reading this manual, be sure to keep it for future reference.

Accessories

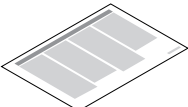
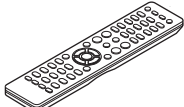
Check that the following parts are supplied with the product.

 <p>Quick Start Guide</p>	 <p>CD-ROM (Owner's Manual)</p>	 <p>Safety Instructions</p>	 <p>Warranty (for North America model only)</p>
 <p>Notes on radio</p>	 <p>Remote control unit (RC-1234)</p>	 <p>R03/AAA batteries</p>	



Inserting the batteries

- 1 Remove the rear lid in the direction of the arrow and remove it.

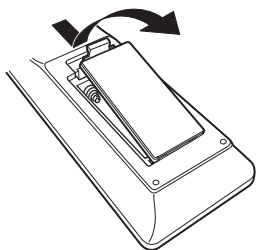

- 2 Insert two batteries correctly into the battery compartment as indicated.

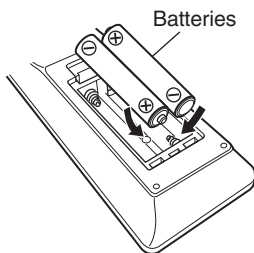

- 3 Put the rear cover back on.

NOTE

- To prevent damage or leakage of battery fluid:
 - Do not use a new battery together with an old one.
 - Do not use two different types of batteries.
- Remove the batteries from the remote control unit if it will not be in use for long periods.
- If the battery fluid should leak, carefully wipe the fluid off the inside of the battery compartment and insert new batteries.

Operating range of the remote control unit

Point the remote control unit at the remote sensor when operating it.

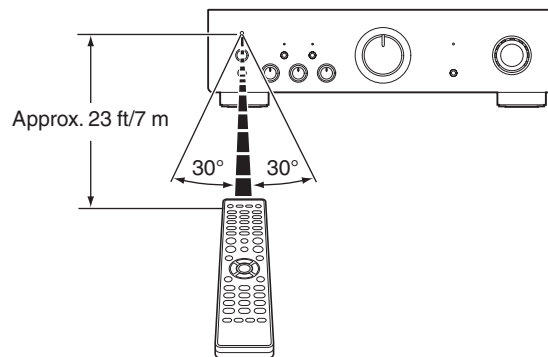

Features

High quality sound

- **Equipped with an advanced high current single push-pull circuit that achieves a perfect balance of delicacy with power**
This unit is equipped with a HC transistor that allows a peak current that is two to three times that of an ordinary audio power transistor, enabling clear and stable musical expression from minute sound to high volumes.

High performance

- **DIGITAL AUDIO IN connectors (COAXIAL/OPTICAL)**
You can play back PCM signals up to 192 kHz/24 bits by inputting digital audio signals from an external device into this unit.
- **Phono input connectors for turntables**
This unit is equipped with a phono amplifier so that you can directly connect a turntable and play records. (Only the MM cartridge can be used.)



Part names and functions

Front panel

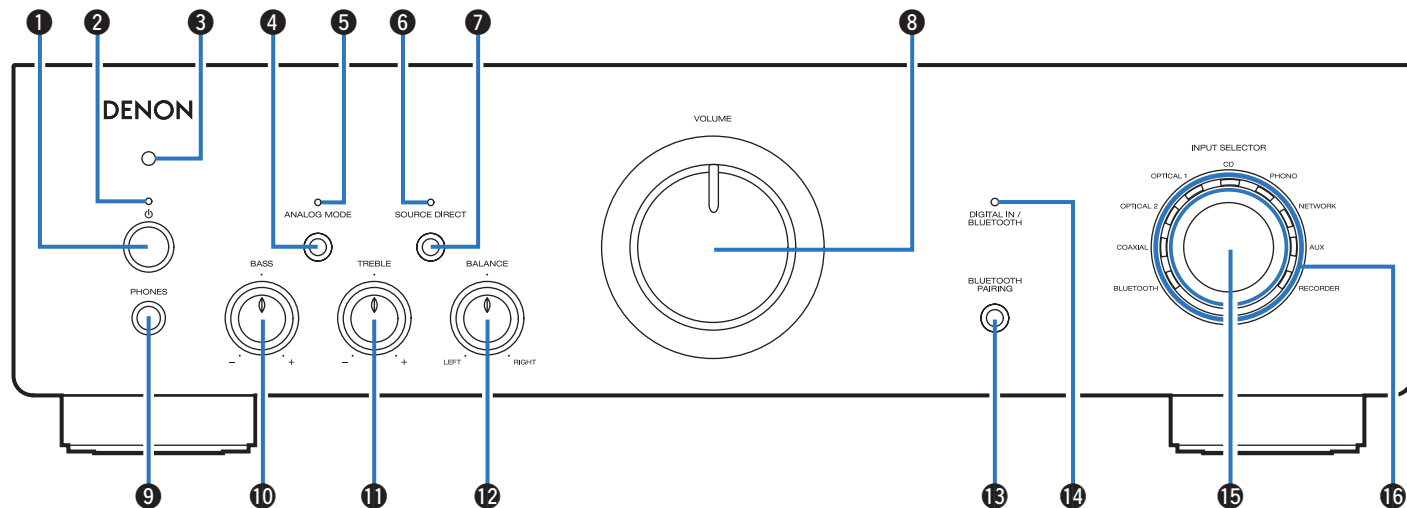

For details, see the next page.



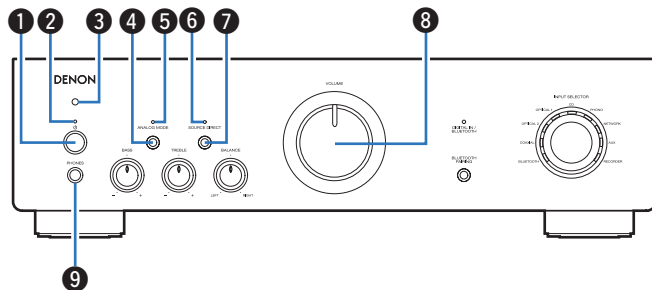

❶ Power operation button (⏻)

This turns the power on/off. (👉 p. 24)

❷ Power indicator

This is displayed as follows according to the power status:

- Lit in green: Power on
- Lit in red: Bluetooth standby (👉 p. 27)
- Off: Normal standby

❸ Remote control sensor

This receives signals from the remote control unit. (👉 p. 5)

❹ ANALOG MODE button

This turns the analog mode on/off.
(👉 p. 27)

❺ ANALOG MODE indicator

This is displayed as follows, according to the analog mode status.

- Lit in green: Analog mode on
- Off: Analog mode off

❻ SOURCE DIRECT indicator

This is displayed as follows according to the source direct status.

- Lit in green: Source direct mode on
- Off: Source direct mode off

❼ SOURCE DIRECT button

This turns source direct mode on/off. (👉 p. 26)

❽ VOLUME knob

This adjusts the volume level. (👉 p. 25)

❾ HEADPHONES jack (PHONES)

Used to connect headphones.

When the headphones are plugged into this jack, audio will no longer be output from the connected speakers or from the PRE OUT connectors.

NOTE

- To prevent hearing loss, do not raise the volume level excessively when using headphones.



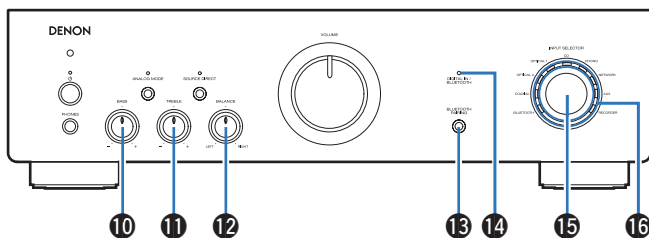

10 BASS control knob

This setting adjusts the volume level for the bass. (☞ p. 25)

11 TREBLE control knob

This setting adjusts the volume level for the treble. (☞ p. 25)

12 BALANCE control knob

This adjusts the balance of the volume output from the left and right speakers. (☞ p. 25)

13 BLUETOOTH/PAIRING button

This switches the input source to "BLUETOOTH". It is also pressed during the pairing operation. (☞ p. 28)

14 DIGITAL IN/BLUETOOTH indicator

- This is displayed as follows, according to the status of the digital audio signals that are input to the digital audio input terminals on this unit.
 - Lit in green: Playback is supported on this unit
 - Blinking in green: Playback is not supported on this unit
 - Off: Sampling frequency cannot be detected



- For details on the audio signal specifications that are compatible with this unit, see "D/A converter" (☞ p. 43).

- This is displayed as follows according to the Bluetooth connection status:
 - Blinking in blue (intervals of about 1 second): Pairing mode
 - Blinking in blue (intervals of about 2 seconds): Searching mode (searching for a paired Bluetooth device and attempting to connect via Bluetooth)
 - Lit in blue: Connecting mode (a Bluetooth connection has been made with a Bluetooth device)
 - Off: Waiting mode (a Bluetooth connection has not been made with any Bluetooth device)

15 INPUT SELECTOR knob

This selects the input source. (☞ p. 25)

16 Input indicators (☞ p. 25)



- 10, 11 and 12 can be adjusted when 6 is off (SOURCE DIRECT mode is off).



Rear panel

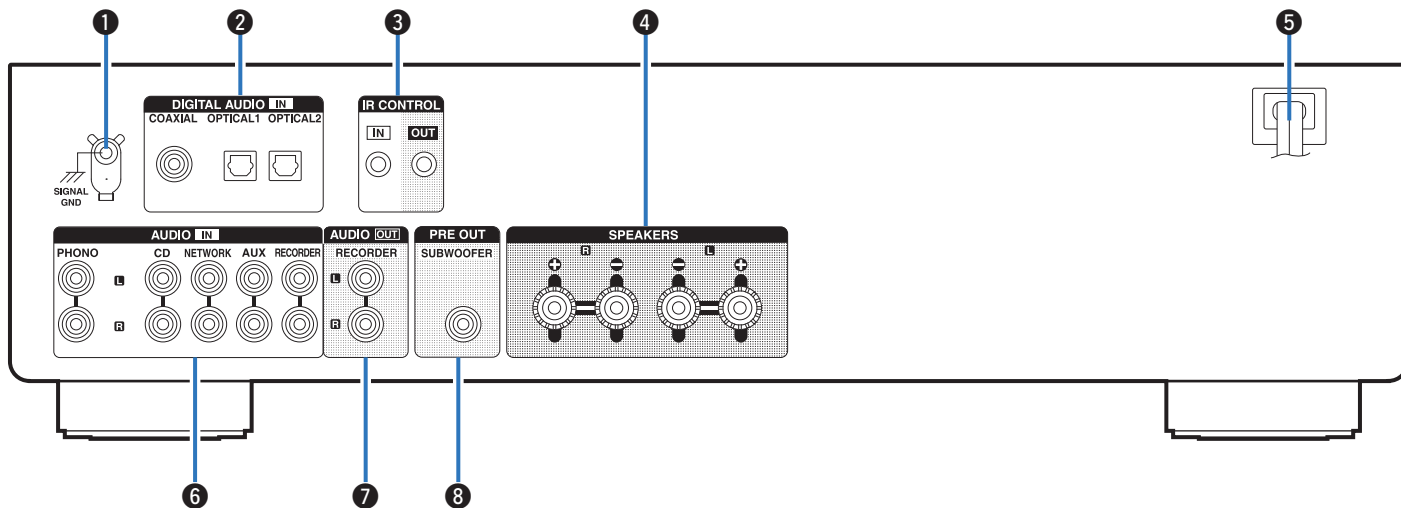

For details, see the next page.



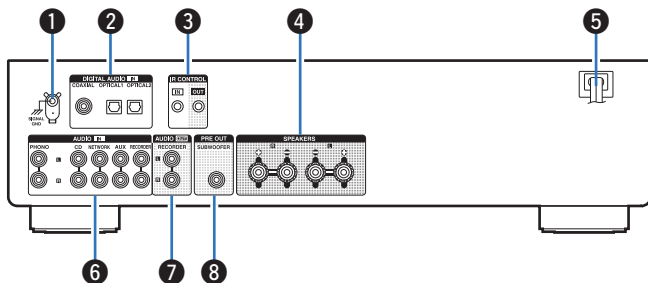

1 SIGNAL GND terminal

Used to connect the ground wire of a turntable.
(☞ p. 19)

2 DIGITAL AUDIO IN connectors

Used to connect devices equipped with digital audio output connectors.
(☞ p. 21)

3 IR CONTROL connectors

Used to connect Denon network audio players with an IR controller.

4 Speaker terminals (SPEAKERS)

Used to connect speakers. (☞ p. 17)

5 Power cord (☞ p. 22)

6 Analog audio connectors (AUDIO IN)

Used to connect devices equipped with analog audio output connectors.

- “Connecting a playback device” (☞ p. 19)
- “Connecting a recording device” (☞ p. 20)

7 AUDIO OUT connectors

Used to connect the input connector of a recorder. (☞ p. 20)

8 PRE OUT connector

Used to connect a subwoofer with a built-in amplifier.
(☞ p. 18)



Remote control unit

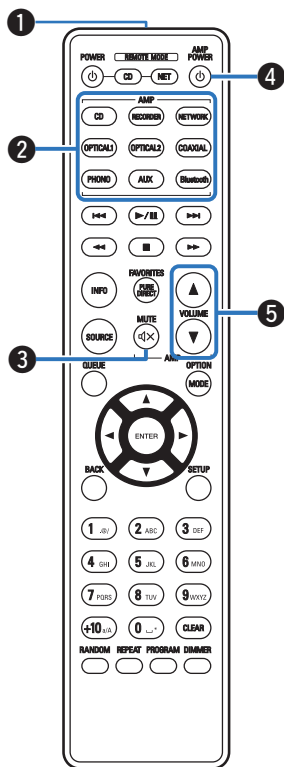

The remote control provided with this unit can control a network audio player in addition to a Denon CD player.

- “CD player operations” (👉 p. 13)
- “Network audio player operations” (👉 p. 14)

■ Operating this unit

1 Remote control signal transmitter

This transmits signals from the remote control unit. (👉 p. 5)

2 Input source select buttons

This selects the input source. (👉 p. 25)

3 MUTE button (🔇)

This mutes the output audio. (👉 p. 25)

4 Power operation button (AMP POWER ⏻)

This turns the power on/off (standby).
(👉 p. 24)

5 VOLUME buttons (▲▼)

These adjust the volume level. (👉 p. 25)



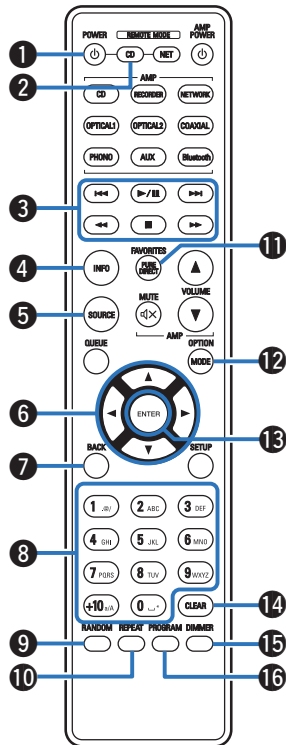

CD player operations

A Denon CD player can be operated.

To operate a CD player, press the REMOTE MODE CD button to switch the remote control to the CD player operation mode.

- 1 Power operation button (POWER ϕ)
- 2 Remote mode select button (REMOTE MODE CD)
- 3 System buttons
- 4 Information button (INFO)
- 5 SOURCE button
- 6 Cursor buttons ($\Delta \nabla \triangleleft \triangleright$)
- 7 BACK button
- 8 Number/letter buttons (0 – 9, +10)
- 9 RANDOM button
- 10 REPEAT button
- 11 PURE DIRECT button
- 12 MODE button
- 13 ENTER button
- 14 CLEAR button
- 15 DIMMER button
- 16 PROGRAM button



- The remote control may not operate some products.



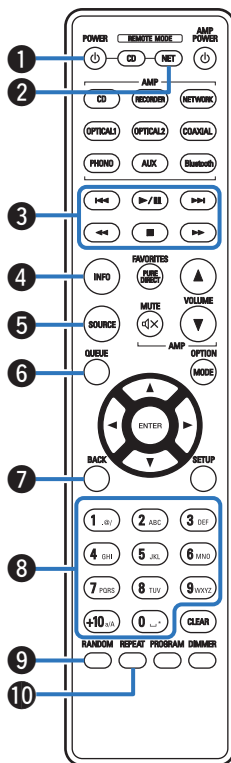

■ Network audio player operations

You can operate a Denon network audio player.

To operate a network audio player, press the REMOTE MODE NET button to switch the remote control to the network audio player operation mode.

- 1 Power operation button (POWER ϕ)
- 2 Remote mode select button (REMOTE MODE NET)
- 3 System buttons
- 4 Information button (INFO)
- 5 SOURCE button
- 6 QUEUE button
- 7 BACK button
- 8 Number/letter buttons (0 – 9, +10)
- 9 RANDOM button
- 10 REPEAT button



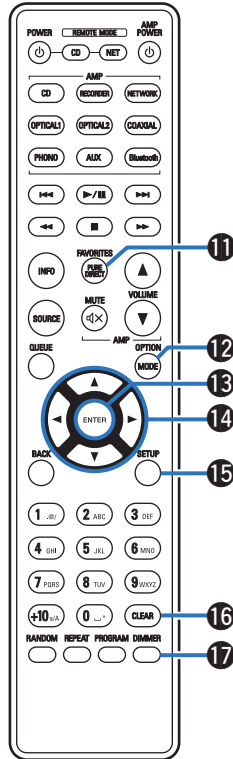

- 11 FAVORITES button
- 12 OPTION button
- 13 ENTER button
- 14 Cursor buttons ($\Delta \nabla \triangleleft \triangleright$)
- 15 SETUP button
- 16 CLEAR button
- 17 DIMMER button



- The remote control may not operate some products.



■ Contents





Connecting speakers	17
Connecting a playback device	19
Connecting a recording device	20
Connecting to a device with digital audio output connectors	21
Connecting the power cord	22

NOTE

- Do not plug in the power cord until all connections have been completed.
- Do not bundle power cords together with connection cables. Doing so can result in humming or noise.

■ Cables used for connections

Provide necessary cables according to the devices you want to connect.

Speaker cable	
Subwoofer cable	
Audio cable	
Optical cable	
Coaxial digital cable	



Connecting speakers

NOTE

- Disconnect this unit's power plug from the power outlet before connecting the speakers. Also, turn off the subwoofer.
- Connect so that the speaker cable core wires do not protrude from the speaker terminal. The protection circuit may be activated if the core wires touch the rear panel or if the + and - sides touch each other. ("Protection circuit" (☞ p. 44))
- Never touch the speaker terminals while the power cord is connected. Doing so could result in electric shock.
- Use speakers with an impedance of 4 – 16 Ω /ohms.

■ Connecting the speaker cables

Carefully check the left (L) and right (R) channels and + (red) and – (black) polarities on the speakers being connected to this unit, and be sure to connect the channels and polarities correctly.

- 1** Peel off about 3/8 inch (10 mm) of sheathing from the tip of the speaker cable, then either twist the core wire tightly or terminate it.



- 2** Turn the speaker terminal counterclockwise to loosen it.



- 3** Insert the speaker cable's core wire to all the way into the speaker terminal.

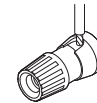

- 4** Turn the speaker terminal clockwise to tighten it.

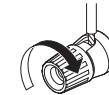

Subwoofer connection

Use a subwoofer cable to connect the subwoofer.

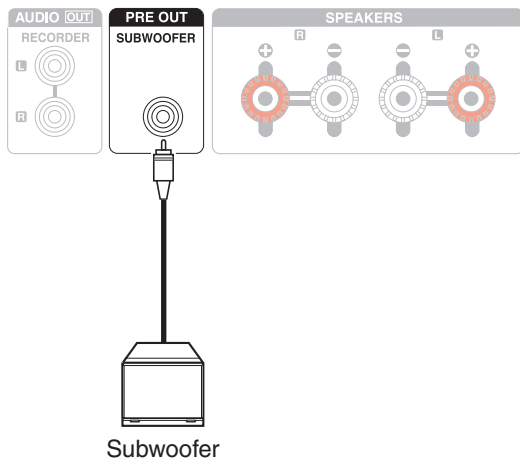

Speaker connection

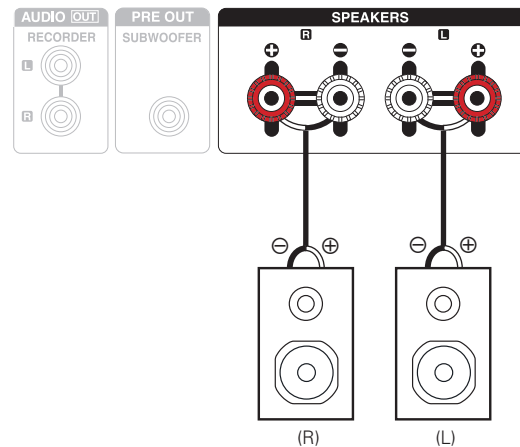

Connecting a playback device

You can connect turntables, CD players, network audio players and Blu-ray Disc players to this unit.

If you set this unit's input source to "PHONO" and you accidentally increase the volume without having a turntable connected, you may hear a hum noise from the speakers.

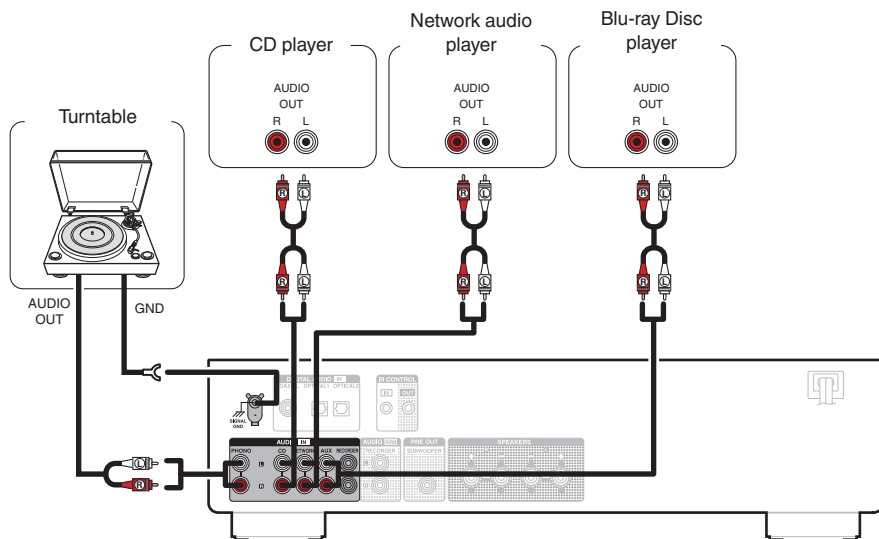

NOTE

- The earth terminal (SIGNAL GND) of this unit is not for safety grounding purposes. If this terminal is connected when there is a lot of noise, the noise can be reduced. Note that depending on the turntable, connecting the ground line may have the reverse effect of increasing noise. In this case, it is not necessary to connect the ground line.



- The PHONO input terminals are equipped with a short pin-plug. Remove this plug to connect a record player. Store the removed short pin-plug in a safe place so as not to lose it.



Connecting a recording device

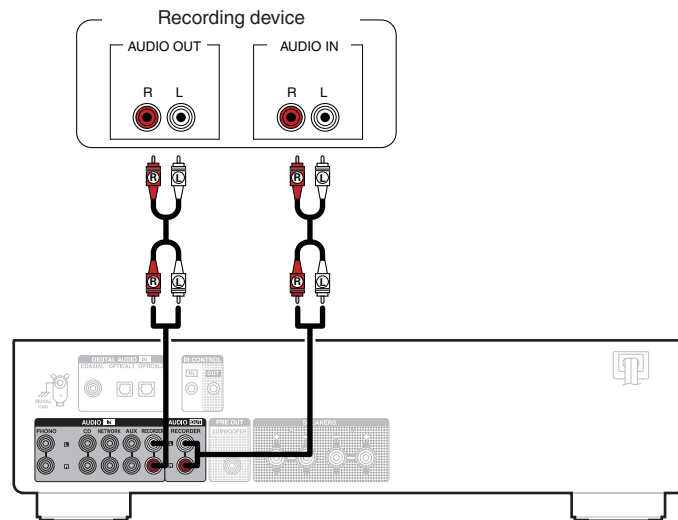

NOTE

- Never insert the short-circuiting pin plug into the RECORDER output connectors. Doing so could result in damage.



Connecting to a device with digital audio output connectors

Input digital audio signals to this unit and convert the signals for playback using the D/A converter of this unit. (👉 p. 30)

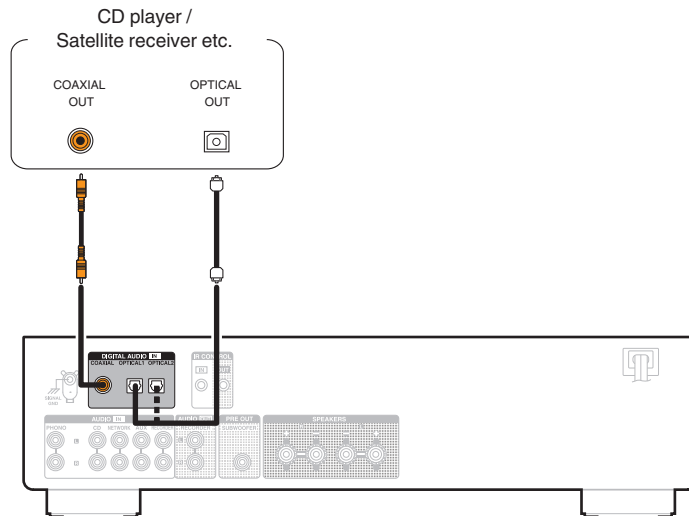

NOTE

- Linear PCM signals with a sampling frequency of 32 kHz, 44.1 kHz, 48 kHz, 88.2 kHz, 96 kHz, 176.4 kHz, or 192 kHz can be input into this unit.
- Do not input non-PCM signals, such as Dolby Digital, DTS and AAC. This causes noise and could damage the speakers.



Connecting the power cord

After completing all the connections, insert the power plug into the power outlet.

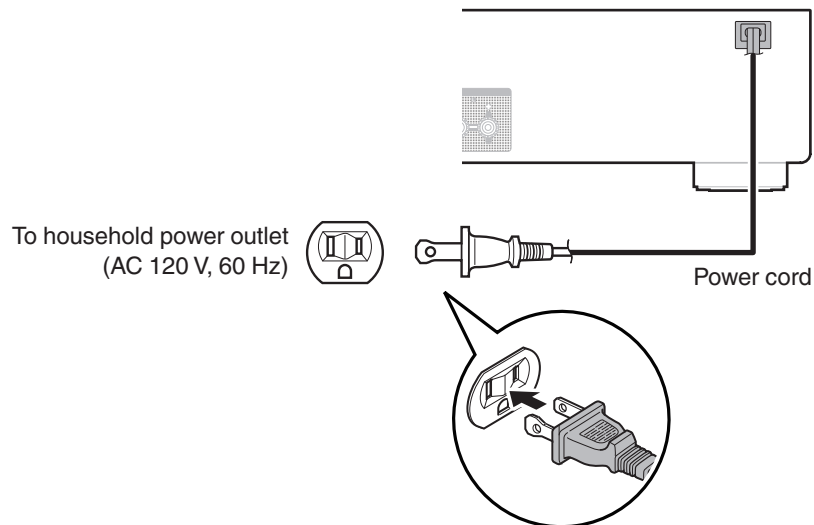

■ Contents

Turning the power on	24
Switching the power to standby	24
Selecting the input source	25
Adjusting the volume	25
Turning off the sound temporarily (Muting)	25
Adjusting the tone	25
Playing CDs	26
Listening to music on a Bluetooth device	28
Connecting and playing back from a digital device (Coaxial/ Optical)	30
Recording	31



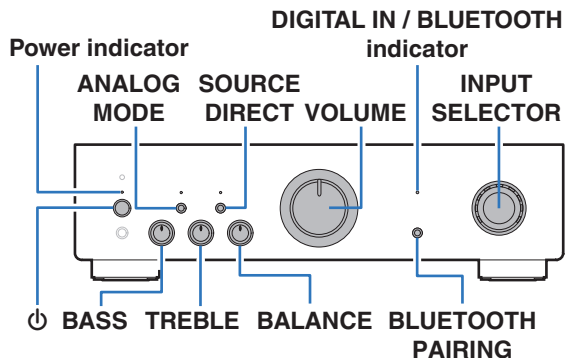
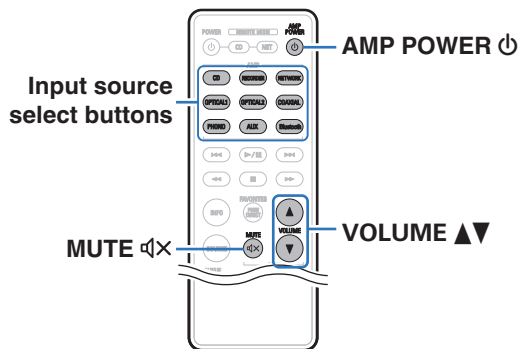

Turning the power on

1 Press on the main unit to turn the power on.

The power indicator lights green.



- Press AMP POWER  on the remote control unit to turn on power from standby mode.

NOTE

- Turn VOLUME on the main unit to adjust the volume to the lowest level before turning on the power.

Switching the power to standby

1 Press AMP POWER .

The unit switches to standby mode.

NOTE

- Power continues to be supplied to some of the circuitry even when the power is in the standby mode. When leaving home for long periods of time or when going on vacation, either press  on the main unit to turn off the power, or unplug the power cord from the power outlet.



Selecting the input source

1 Press the input source select button to be played back.

The indicator of the selected input source lights.



- You can also select the input source by turning INPUT SELECTOR on the main unit.

Adjusting the volume

1 Use VOLUME ▲▼ to adjust the volume.



- You can also adjust the volume by turning VOLUME on the main unit.

Turning off the sound temporarily (Muting)

1 Press MUTE .

The power indicator flashes green.



- To cancel mute, press MUTE  again.

Adjusting the tone

1 Press SOURCE DIRECT on the main unit to turn off source direct mode.

The SOURCE DIRECT indicator turns off.

2 Turn the BASS, TREBLE and BALANCE knobs to adjust the tone.



Playing CDs

This section uses playback from a CD as an example.

- 1 Press the input source select button (CD) to switch the input source to "CD".**
The "CD" input indicator lights.
- 2 Playback the CD.**
- 3 Use VOLUME ▲▼ to adjust the volume.**

■ Playback in source direct mode

The signal does not pass through the tone adjustment circuitry (BASS, TREBLE and BALANCE), resulting in playback of a higher sound quality.

- 1 Press SOURCE DIRECT on the main unit to turn on source direct mode.**
The SOURCE DIRECT indicator lights.



■ Playback in ANALOG MODE

If analog mode is turned on when playing an analog input source (PHONO, CD, NETWORK, AUX, RECORDER), power to the digital input circuit and Bluetooth module is turned off. This enables you to enjoy audio playback with high sound quality without sound quality being affected by noise that occurs from the digital control circuit.

1 Press ANALOG MODE on the main unit to turn analog mode on.

ANALOG MODE indicator lights.

- Analog mode switches on or off each time the button is pressed.

Analog mode on:	The power of the digital input circuit and Bluetooth module is turned off.
Analog mode off:	Analog mode is not used.



- A digital input source (“COAXIAL”, “OPTICAL 1”, “OPTICAL 2”) or “BLUETOOTH” source cannot be selected when analog mode is on.
- The input source automatically switches to “CD” if analog mode is turned on during playback of a digital input source (“COAXIAL”, “OPTICAL 1”, “OPTICAL 2”) or “BLUETOOTH” source.
- When the analog mode is switched, the mute circuit is activated for about 5 seconds.



Listening to music on a Bluetooth device

Music files stored on Bluetooth devices such as smartphones, digital music players, etc. can be enjoyed on this unit by pairing and connecting this unit with the Bluetooth device.

In order to enjoy music from a Bluetooth device on this unit, the Bluetooth device must first be paired with this unit.

Once the Bluetooth device has been paired, it does not need to be paired again.



- Communication is possible up to a range of about 98.4 ft/30 m.
- To play back music from a Bluetooth device, the Bluetooth device needs to support the A2DP profile.

1 Press the input source select button (Bluetooth) to switch the input source to “BLUETOOTH”.

When using for the first time, the unit will go into the pairing mode automatically and the DIGITAL IN/BLUETOOTH indicator will blink in blue in intervals of about 1 second.



- The Bluetooth function does not work when analog mode is on. Turn the analog mode off. (☞ p. 27)

2 Activate the Bluetooth settings on your Bluetooth device.

3 Select this unit when its name appears in the list of devices displayed on the screen of the Bluetooth device.

The DIGITAL IN/BLUETOOTH indicator lights in blue when pairing is complete.

- Connect the Bluetooth device while the DIGITAL IN/BLUETOOTH indicator is blinking in blue in intervals of about 1 second. Perform the connection with the Bluetooth device close to the unit (about 3.3 ft/1 m).



4 Play music using any app on your Bluetooth device.

- The next time the input source is switched to “BLUETOOTH”, this unit automatically connects to the last Bluetooth device that was connected.



- When this unit's name is not displayed in the screen on the Bluetooth device, search for devices on the Bluetooth device.
- Enter “0000” when the password is requested on the screen of the Bluetooth device.
- The pairing mode on this unit lasts for approx. 5 minutes. When the pairing mode on this unit is canceled before the pairing is completed, retry from step 1.
- This unit cannot perform pairing against a Bluetooth device with a pass key other than “0000”.

■ Pairing with other Bluetooth devices

Pair a Bluetooth device with this unit.

1 Activate the Bluetooth settings on your Bluetooth device.

2 Press and hold the input source switching button (Bluetooth) for at least 3 seconds.

The device will go into the pairing mode.

- You can also switch to pairing mode by pressing and holding BLUETOOTH PAIRING on this unit for at least 3 seconds.

3 Select this unit when its name appears in the list of devices displayed on the screen of the Bluetooth device.

When pairing is completed, the DIGITAL IN/BLUETOOTH indicator is lit in blue.



- This unit can be paired with a maximum of 8 Bluetooth devices. When a 9th Bluetooth device is paired, it will be registered in place of the oldest registered device.
- Enter “0000” when the password is requested on the screen of the Bluetooth device.



■ Reconnecting to this unit from a Bluetooth device

After pairing is completed, the Bluetooth device can be connected without performing any operations on this unit.

This operation also needs to be performed when switching the Bluetooth device for playback.

- 1** If a Bluetooth device is currently connected, deactivate the Bluetooth setting of that device to disconnect it.
- 2** Activate the Bluetooth setting of the Bluetooth device to be connected.
- 3** Select this unit from the Bluetooth device list on your Bluetooth device.
- 4** Play music using any app on your Bluetooth device.



- When the power of this unit is turned on and analog mode is off, the input source will be automatically switched to "BLUETOOTH" if a Bluetooth device is connected.
- When a Bluetooth device is connected with the unit while on Bluetooth standby state (while the power indicator is lit in red), the power of the unit will be turned on automatically. To enable Bluetooth standby, set this unit to standby when analog mode is off. (☞ p. 27)

Connecting and playing back from a digital device (Coaxial/Optical)

- 1** Connect digital device to this unit. (☞ p. 21)
- 2** Press the input source select button (COAXIAL, OPTICAL 1 or OPTICAL 2) to switch the input source to "COAXIAL", "OPTICAL 1" or "OPTICAL 2".
The indicator of the selected input source lights.
- 3** Start playback of the digital device connected to this unit.
The DIGITAL IN/BLUETOOTH indicator lights in green.



- The DIGITAL IN/BLUETOOTH indicator blinks in green when audio signals that are not supported by this unit are input.
- If the sampling frequency cannot be detected, the DIGITAL IN/BLUETOOTH indicator turns off.



■ Audio signals that can be played back

See “D/A converter” (🔍 p. 43).

NOTE

- Do not input non-PCM signals, such as Dolby Digital, DTS and AAC. This causes noise and could damage the speakers.
- If the sampling frequency switches, the sound may be cut for 1–2 seconds.

Recording

Audio signals input into this unit can be output to an external recording device. When recording audio from a playback device connected to this unit, audio can be recorded with the playback device still connected to this unit.

- 1 Press  on the main unit to turn the power on.**
- 2 Press the input source select button to switch to the input source from which you want to record.**
The indicator of the selected input source lights.
- 3 Recording starts.**
 - For information on operations, see the owner’s manual of the recording device.



Setting the Auto Standby mode

You can set the unit to automatically switch to standby mode if the unit is not operated for 30 minutes when there is no audio input (Auto Standby mode).

Auto Standby mode is set to off by default.

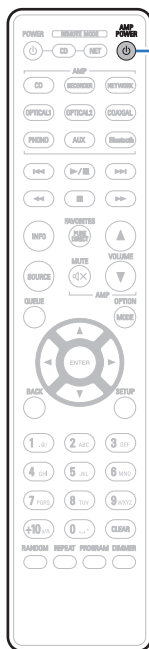

AMP POWER 

1 Press and hold AMP POWER for 5 seconds or more to switch it on and off.

The power indicator changes as follows each time it is switched on and off.

- When auto standby mode is on: The power indicator blinks in green three times.
- When auto standby mode is off: The power indicator blinks in green once.



■ Contents

Tips

I want to turn on power to this unit from a Bluetooth device	34
I want to adjust the tone myself	34
I want sound playback that is faithful to the original sound	34
I want to enjoy higher sound quality from the analog input source	34

Troubleshooting

Power does not turn on / Power is turned off	36
Operations cannot be performed through the remote control unit	37
No sound comes out	38
Desired sound does not come out	39
Sound is interrupted or noise occurs	40
Bluetooth cannot be played back	41
Audio from digital devices cannot be played back (Coaxial/Optical)	42



Tips

I want to turn on power to this unit from a Bluetooth device

- When this unit is on Bluetooth standby (the power indicator is lit in red), the power of this unit can be turned on by selecting this unit from the device list on a Bluetooth device paired with this unit. (👉 p. 30)

I want to adjust the tone myself

- Use the BASS, TREBLE and BALANCE knobs to adjust the sound as desired. (👉 p. 25)

I want sound playback that is faithful to the original sound

- Set the source direct mode on. (👉 p. 26)

I want to enjoy higher sound quality from the analog input source

- Set the analog mode on. (👉 p. 27)



Troubleshooting

If a problem should arise, first check the following:

1. **Are the connections correct?**
2. **Is the set being operated as described in the owner's manual?**
3. **Are the other devices operating properly?**

If this unit does not operate properly, check the corresponding symptoms in this section.

If the symptoms do not match any of those described here, consult your dealer as it could be due to a fault in this unit. In this case, disconnect the power immediately and contact the store where you purchased this unit.



Power does not turn on / Power is turned off

Power is not turned on.

- Check whether the power plug is correctly inserted into the power outlet. (👉 p. 22)

Power automatically turns off.

- The Auto Standby mode setting is on. The Auto Standby mode switches the unit to standby mode when there is no audio input and the unit is not operated for approximately 30 minutes. To disable the Auto Standby mode, press and hold the AMP POWER ⏻ button for more than 5 seconds when the Auto Standby mode is enabled. (👉 p. 32)

The power turns off and the power indicator shows one long blink and four short blinks in red.

- The protection circuit has been activated due to a rise in temperature within this unit. Turn the power off, wait about an hour until this unit cools down sufficiently, and then turn the power on again. (👉 p. 44)
- Please re-install this unit in a place having good ventilation.

The power turns off and the power indicator shows one long blink and five short blinks in red.

- Check the speaker connections. The protection circuit may have been activated because speaker cable core wires came in contact with each other or a core wire was disconnected from the connector and came in contact with the rear panel of this unit. After unplugging the power cord, take corrective action such as firmly re-twisting the core wire or taking care of the connector, and then reconnect the wire. (👉 p. 17)
- Turn down the volume and turn on the power again. (👉 p. 24)

When the power is turned on, the power indicator shows one long blink and three or six short blinks in red.

- This unit's amplifier circuit has failed. Unplug the power cord and contact our customer service center.



Operations cannot be performed through the remote control unit

Operations cannot be performed through the remote control unit.

- Batteries are worn out. Replace with new batteries. (👉 p. 5)
- Operate the remote control unit within a distance of about 23 ft/7 m from this unit and at an angle of within 30°. (👉 p. 5)
- Remove any obstacle between this unit and the remote control unit.
- Insert the batteries in the proper direction, checking the ⊕ and ⊖ marks. (👉 p. 5)
- The set's remote control sensor is exposed to strong light (direct sunlight, inverter type fluorescent bulb light, etc.). Move the set to a place in which the remote control sensor will not be exposed to strong light.
- When using a 3D video device, the remote control unit of this unit may not function due to effects of infrared communications between units (such as TV and glasses for 3D viewing). In this case, adjust the direction of units with the 3D communications function and their distance to ensure they do not affect operations from the remote control unit of this unit.



No sound comes out

No sound comes out of speakers.

- Check the connections for all devices. (👉 p. 16)
- Insert connection cables all the way in.
- Check that input connectors and output connectors are not reversely connected.
- Check cables for damage.
- Check that speaker cables are properly connected. Check that cable core wires come in contact with the metal part on speaker terminals. (👉 p. 17)
- Securely tighten the speaker terminals. Check speaker terminals for looseness. (👉 p. 17)
- Check that the proper input source is selected. (👉 p. 25)
- The volume is set to the minimum level. Adjust the volume to a suitable level. (👉 p. 25)
- Cancel the muting mode. (👉 p. 25)
- Check that the correct input source is selected when audio is being input to this unit from an external device. (👉 p. 25)
- Check the digital audio output setting on the connected device. The initial settings may be off depending on the device.
- When a headphone plug is inserted into the headphone jack of the unit, no sound is output from the speakers. (👉 p. 8)



Desired sound does not come out

No sound comes out of a specific speaker.

- Check that speaker cables are properly connected. (👉 p. 17)
- Adjust the BALANCE control knob. (👉 p. 25)

The left and right of stereo sound is reversed.

- Check whether the left and right speakers are connected to the correct speaker terminals. (👉 p. 17)

No sound is produced from subwoofer.

- Check the subwoofer connections. (👉 p. 18)
- Turn on the subwoofer's power.



Sound is interrupted or noise occurs

When playing a record, the sound is distorted.

- Adjust to a proper needle pressure.
- Check the tip of the needle.
- Replace the cartridge.

When playing a record, a humming noise comes out of the speakers.

- Check that the turntable is connected correctly. (👉 p. 19)
- If there is a TV or AV device near the turntable, such devices may affect the playback sound. Install the turntable in a location as far away as possible from the TV or other AV devices.

When playing a record, a humming noise comes out of the speakers when the volume is high. (Howling phenomenon)

- Install the turntable and speakers as far from each other as possible. (👉 p. 19)
- The vibrations from the speakers are being transmitted to the player through the floor. Use cushions, etc., to absorb the speakers' vibrations.



Bluetooth cannot be played back

Bluetooth devices cannot be connected to this unit.

- The Bluetooth function in the Bluetooth device has not been enabled. See the Owner's Manual of the Bluetooth device to enable the Bluetooth function.
- Bring the Bluetooth device near to this unit.
- The Bluetooth device cannot connect with this unit if it is not compatible with the A2DP profile.
- Turn the power of the Bluetooth device off and on again, and then try again.
- Change the analog mode setting to Off. The Bluetooth function does not work when the analog mode setting is On. (👉 p. 27)
- To playback via a Bluetooth connection, perform pairing between this unit and the Bluetooth device. (👉 p. 28)

The sound is cut off.

- Bring the Bluetooth device near to this unit.
- Remove obstructions between the Bluetooth device and this unit.
- To prevent electromagnetic interference, locate this unit away from microwave ovens, wireless LAN devices and other Bluetooth devices.
- Reconnect the Bluetooth device.



Audio from digital devices cannot be played back (Coaxial/Optical)

The DIGITAL IN/BLUETOOTH indicator is off.

- When digital audio signals cannot be detected properly, the DIGITAL IN/BLUETOOTH indicator is off. (👉 p. 30)

The DIGITAL IN/BLUETOOTH indicator is blinking in green.

- The DIGITAL IN/BLUETOOTH indicator blinks in green when audio signals that are not supported by this unit are input. Check the audio output signal format from your digital device. (👉 p. 30)
- Do not input non-PCM signals, such as Dolby Digital, DTS and AAC. This causes noise and could damage the speakers.



D/A converter

■ Specifications of supported audio signals

□ Coaxial/Optical

	Sampling frequency	Bit length
Linear PCM (2-channel)	32/44.1/48/88.2/96/ 176.4/192 kHz	16/24 bits

Playing back a Bluetooth device

This unit supports the following Bluetooth profile.

- A2DP (Advanced Audio Distribution Profile):
When a Bluetooth device that supports this standard is connected, monaural and stereo sound data can be streamed at a high quality.

■ About Bluetooth communications

Radio waves broadcast from this unit may interfere with the operation of medical devices. Make sure you turn off the power of this unit and Bluetooth device in the following locations as radio wave interference may cause malfunctions.

- Hospitals, trains, aircraft, petrol kiosks and places where flammable gases are generated
- Near automatic doors and fire alarms



Explanation of terms

Sampling frequency

Sampling involves taking a reading of a sound wave (analog signal) at regular intervals and expressing the height of the wave at each reading in digitized format (producing a digital signal).

The number of readings taken in one second is called the “sampling frequency”. The larger the value, the closer the reproduced sound is to the original.

Linear PCM

This is an uncompressed PCM (Pulse Code Modulation) signal. This is the same system used for CD audio but uses 192 kHz, 96 kHz, and 48 kHz sampling frequencies on Blu-ray Disc or DVD and provides higher resolution than CD.

Speaker impedance

This is an AC resistance value, indicated in Ω (ohms). Greater power can be obtained when this value is smaller.

Source direct

Playback with higher fidelity to the source becomes possible, as input audio signals are output by bypassing the audio quality-control circuits (BASS/TREBLE/BALANCE).

Pairing

Pairing (registration) is an operation that is required in order to connect a Bluetooth device to this unit using Bluetooth. When paired, the devices authenticate each other and can connect without mistaken connections occurring.

When using Bluetooth connection for the first time, you need to pair this unit and the Bluetooth device to be connected.

Protection circuit

This is a function to prevent damage to devices within the power supply when an abnormality such as an overload, excess voltage occurs or over temperature for any reason.



Trademark information



The Bluetooth® word mark and logos are registered trademarks owned by the Bluetooth SIG, Inc. and any use of such marks by D&M Holdings Inc. is under license. Other trademarks and trade names are those of their respective owners.



Adobe, the Adobe logo and Reader are either registered trademarks or trademarks of Adobe Systems Incorporated in the United States and/or other countries.



Specifications

■ Power amplifier section

Rated Output Power:	2-channel driving (CD → SP OUT) 45 W + 45 W (8 Ω/ohms, 20 Hz - 20 kHz, T.H.D. 0.07 %) 70 W + 70 W (4 Ω/ohms, 1 kHz, T.H.D. 0.7%)
Total harmonic distortion:	0.01 % (Rated output: -3 dB), 8 Ω/ohms, 1 kHz
Output terminals:	Speaker: 4 – 16 Ω/ohms Suited for headphones/stereo headphones

■ Pre amplifier section

Input Sensitivity/Input Impedance:	PHONO (MM): 2.5 mV / 47 kΩ/kohms CD, NETWORK, AUX, RECORDER: 100 mV / 40 kΩ/kohms (SOURCE DIRECT: Off) 100 mV / 17 kΩ/kohms (SOURCE DIRECT: On)
RIAA Deviation:	PHONO: 20 Hz – 20 kHz ±0.5 dB
Maximum Input:	PHONO (MM): 70 mV / 1 kHz
Output level:	PRE OUT (SUBWOOFER): 1 V / 100 Hz (Input 100 mV, Volume: Max)



■ Overall performance

SN Ratio (A network):

PHONO (MM): 84 dB

(With input terminals short-circuited, 5 mV input signal)

CD, NETWORK, AUX, RECORDER: 105 dB (input terminals short-circuited)

Frequency response:

5 Hz – 100 kHz (0 – -3 dB)

Tone control:BASS: 100 Hz \pm 8 dBTREBLE: 10 kHz \pm 8 dB**• Digital input signal format****Format:**

Digital audio interface (Linear PCM)

Coaxial input:0.5 V_{p-p} / 75 Ω /ohms**Optical input:**

More than -27 dBm

Optical wavelength:

660 nm



■ Bluetooth section

Communications system:	Bluetooth Version 4.2
Transmission power:	Bluetooth Specification Power Class 1
Maximum communication range:	Approx. 98.4 ft/30 m in line of sight *
Used frequency range:	2.4 GHz
Modulation scheme:	FHSS (Frequency-Hopping Spread Spectrum)
Supported profiles:	A2DP (Advanced Audio Distribution Profile) 1.3 AVRCP (Audio Video Remote Control Profile) 1.6
Corresponding codec:	SBC AAC
Transmission range (A2DP):	20 Hz – 20,000 Hz

*The actual communication range varies depending on the influence of such factors as obstructions between devices, electromagnetic waves from microwave ovens, static electricity, cordless phones, reception sensitivity, antenna performance, operating system, application software etc.

■ General

Operating temperature:	41 °F - 95 °F (5 °C - 35 °C)
Power supply:	AC 120 V, 60 Hz
Power consumption:	190 W
Power consumption in standby mode :	0.3 W
Power consumption when Bluetooth standby is used:	0.6 W

For the purpose of improvement, the specifications and design are subject to change without notice.



■ Dimensions (Unit : in. (mm))

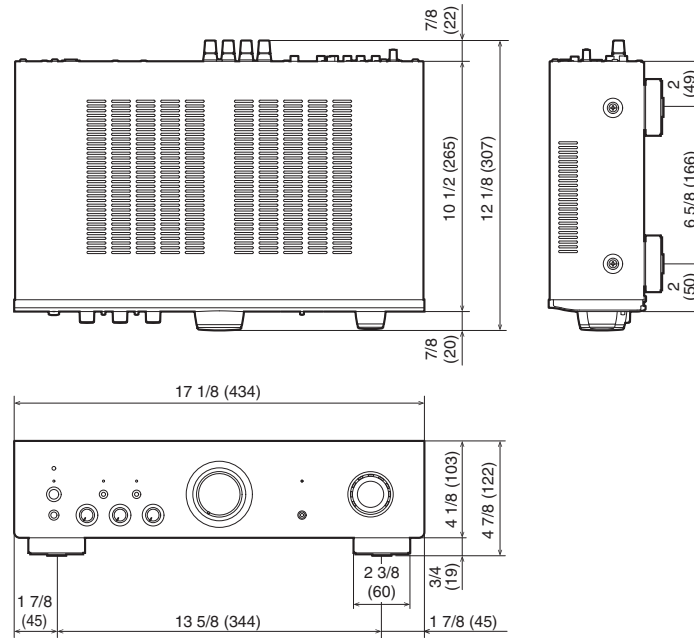

■ Weight : 16 lb 5 oz (7.4 kg)



Index

A		I		S	
Auto Standby mode	32	Input source	25	Satellite receiver	21
B		M		Source direct	26, 44
BALANCE	25	Muting	25	Speaker impedance	44
BASS	25	N		Speakers	17
Bluetooth device	28	Network audio player	19	T	
Blu-ray Disc player	19	P		Tips	34
C		Protection circuit	44	Tone	25
CD player	19, 21	R		TREBLE	25
D		Recording device	20	Troubleshooting	35
D/A Converter	43	Remote control unit	12	Turntable	19
		V		Volume	25



DENON[®]

www.denon.com

3520 10698 10AD

Copyright © 2019 D&M Holdings Inc. All Rights Reserved.