

# DENON<sup>®</sup>

## PMA-800NE

INTEGRATED AMPLIFIER

# Owner's Manual

You can print more than one page of a PDF onto a single sheet of paper.

[Front panel](#)[Rear panel](#)[Remote control  
unit](#)[Index](#)

<b>Accessories</b>	<b>4</b>
Inserting the batteries	5
Operating range of the remote control unit	5
<b>Features</b>	<b>6</b>
High quality sound	6
High performance	6
<b>Part names and functions</b>	<b>7</b>
Front panel	7
Rear panel	10
Remote control unit	12

## Connections

<b>Connecting speakers</b>	<b>17</b>
Speaker connection	18
Bi-wiring connection	19
<b>Connecting a playback device</b>	<b>20</b>
<b>Connecting a recording device</b>	<b>21</b>
<b>Connecting to a device with digital audio output connectors</b>	<b>22</b>
<b>Connecting the power cord</b>	<b>23</b>

## Playback

Turning the power on	25
Switching the power to standby	25
Selecting the speakers for audio output	26
Selecting the input source	26
Adjusting the volume	26
Turning off the sound temporarily (Muting)	27
Adjusting the tone	27
Playing CDs	27
Connecting and playing back from a digital device (Coaxial/ Optical)	29
Recording	30

## Settings

<b>Setting the Auto Standby mode</b>	<b>31</b>
Turning Auto Standby mode on	31
Turning Auto Standby mode off	31



## Tips

<b>Tips</b>	<b>33</b>
<b>Troubleshooting</b>	<b>34</b>
Power does not turn on / Power is turned off	35
Operations cannot be performed through the remote control unit	36
No sound comes out	37
Desired sound does not come out	37
Sound is interrupted or noise occurs	38
Audio from digital devices cannot be played back (Coaxial/ Optical)	39

## Appendix





<b>D/A converter</b>	<b>40</b>
<b>Explanation of terms</b>	<b>40</b>
<b>Trademark information</b>	<b>41</b>
<b>Specifications</b>	<b>42</b>
<b>Index</b>	<b>45</b>

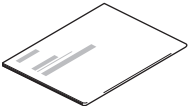
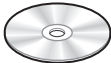

Thank you for purchasing this Denon product. To ensure proper operation, please read this owner's manual carefully before using the product. After reading this manual, be sure to keep it for future reference.

## Accessories

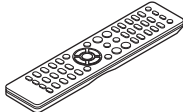
Check that the following parts are supplied with the product.

 Quick Start Guide	 CD-ROM (Owner's Manual)	 Safety Instructions	 Warranty (for North America model only)
 Remote control unit (RC-1223)	 R03/AAA batteries		



## Inserting the batteries

- 1 Remove the rear lid in the direction of the arrow and remove it.

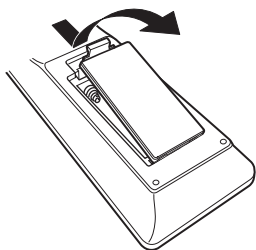

- 2 Insert two batteries correctly into the battery compartment as indicated.

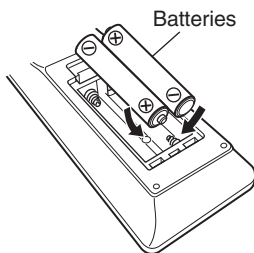

- 3 Put the rear cover back on.

### NOTE

- To prevent damage or leakage of battery fluid:
  - Do not use a new battery together with an old one.
  - Do not use two different types of batteries.
- Remove the batteries from the remote control unit if it will not be in use for long periods.
- If the battery fluid should leak, carefully wipe the fluid off the inside of the battery compartment and insert new batteries.

## Operating range of the remote control unit

Point the remote control unit at the remote sensor when operating it.

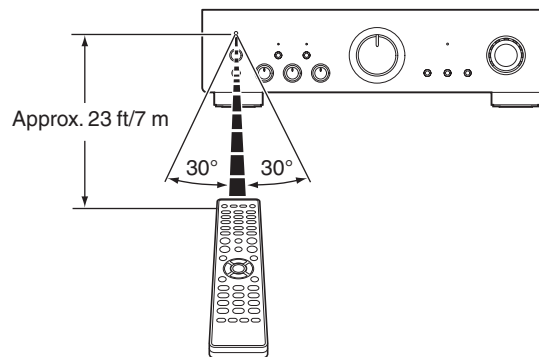

# Features

## High quality sound

- **Equipped with an advanced high current single push-pull circuit that achieves a perfect balance of delicacy with power**

Equipped with a HC transistor that allows a peak current that is two to three times that of an ordinary audio power transistor that enables clear and stable musical expression from minute levels to high volumes.

- **High Speed, Large Current Compatible Power Circuit**

The power circuit is equipped with Denon's customized block type electrolytic capacitor and SBD (Schottky-Barrier Diode) that features a short reverse recovery time and low rectification noise in order to draw out the full capabilities of the HC single push-pull circuit.

## High performance

- **DIGITAL AUDIO IN connectors (COAXIAL/OPTICAL)**

You can play back PCM signals up to 192 kHz/24 bits by inputting digital audio signals from an external device into this unit.

- **Phono Equalizer**

Even a user who is particular about analog records is satisfied because the Phono Equalizer circuit for the FET input supports MM/MC.



## Part names and functions

### Front panel

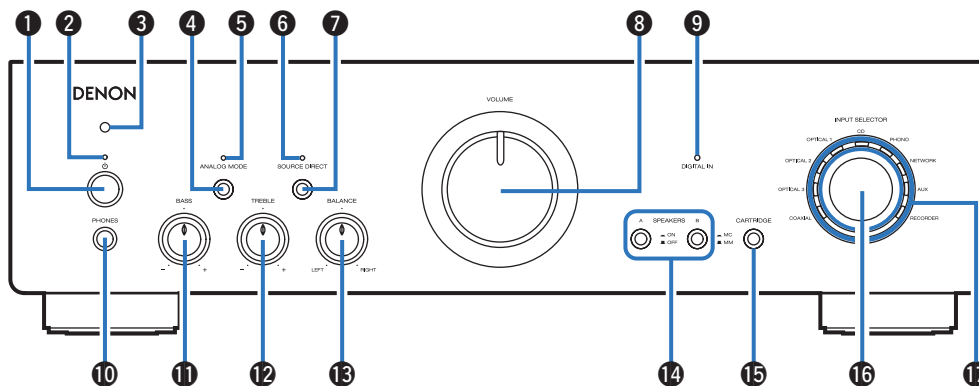

#### 1 Power operation button (⏻)

This turns the power on/off. (👉 p. 25)

#### 2 Power indicator

This is lit as follows according to the power status:

- Power on : Green
- Standby : Off
- Power off : Off
- When the protection circuit is activated : Red (blinking)



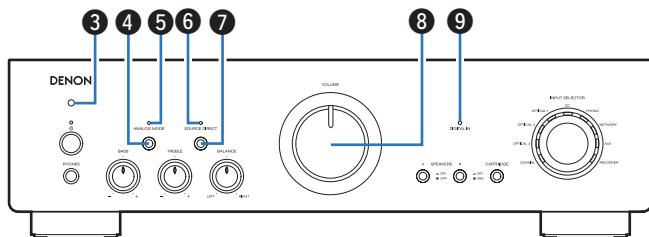

### 3 Remote control sensor

This receives signals from the remote control unit. (👉 p. 5)

### 4 ANALOG MODE button

This turns the analog mode on/off. (👉 p. 28)

### 5 ANALOG MODE indicator

This is lit as follows, according to the analog mode status.

- Analog mode on: Green
- Analog mode off: Off

### 6 SOURCE DIRECT indicator

This is lit as follows according to the source direct status.

- Source direct mode on: Green
- Source direct mode off: Off

### 7 SOURCE DIRECT button

This turns source direct mode on/off. (👉 p. 28)

### 8 VOLUME knob

This adjusts the volume level. (👉 p. 26)

### 9 DIGITAL IN indicator

This is lit as follows, according to the status of the digital audio signals that are input to the digital audio input terminals on this unit.

- When playback is supported on this unit: Green
- When playback is not supported on this unit: Flashing
- When the sampling frequency cannot be detected: Off



- For details on the audio signal specifications that are compatible with this unit, see "D/A converter" (👉 p. 40).





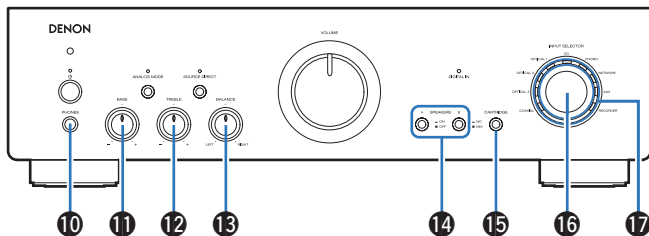

### 10 Headphones jack (PHONES)

Used to connect headphones.

Press the SPEAKERS A/B button on the main unit to turn off speaker output when using headphones. (🔗 p. 26)

#### NOTE

- To prevent hearing loss, do not raise the volume level excessively when using headphones.

### 11 BASS control knob

This setting adjusts the volume level for the bass. (🔗 p. 27)

### 12 TREBLE control knob

This setting adjusts the volume level for the treble. (🔗 p. 27)

### 13 BALANCE control knob

This adjusts the balance of the volume output from the left and right speakers. (🔗 p. 27)

### 14 SPEAKERS A/B buttons

These select the speaker for audio output. (🔗 p. 26)

### 15 CARTRIDGE button

Switch between MM (■) or MC (■) to match the type of cartridge used in the record player connected to this unit.

### 16 INPUT SELECTOR knob

This selects the input source. (🔗 p. 26)

### 17 Input indicators (🔗 p. 26)



- 11, 12 and 13 can be adjusted when 6 is off (SOURCE DIRECT mode is off).



## Rear panel

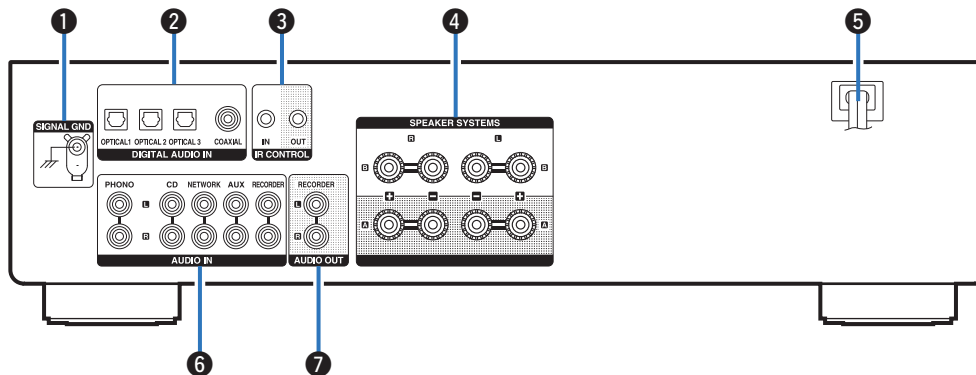

### 1 SIGNAL GND terminal

Used to connect the ground wire of a turntable.  
(☞ p. 20)

### 2 DIGITAL AUDIO IN connectors

Used to connect devices equipped with digital audio output connectors.  
(☞ p. 22)

### 3 IR CONTROL connectors

Used to connect Denon network audio players with an IR controller.



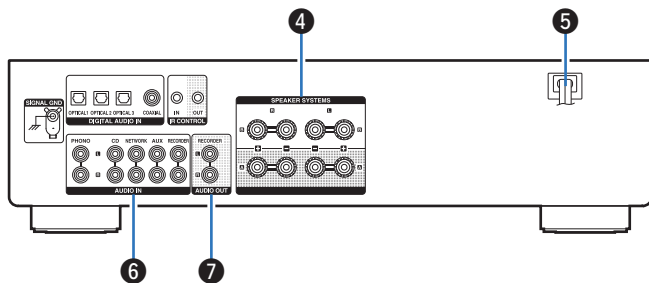

#### 4 Speaker terminals (SPEAKER SYSTEMS)

Used to connect speakers. (☞ p. 17)

#### 5 Power cord (☞ p. 23)

#### 6 AUDIO IN connectors

Used to connect devices equipped with analog audio output connectors.

- “Connecting a playback device” (☞ p. 20)
- “Connecting a recording device” (☞ p. 21)

#### 7 AUDIO OUT connectors

Used to connect the input connector of a recorder. (☞ p. 21)



## Remote control unit

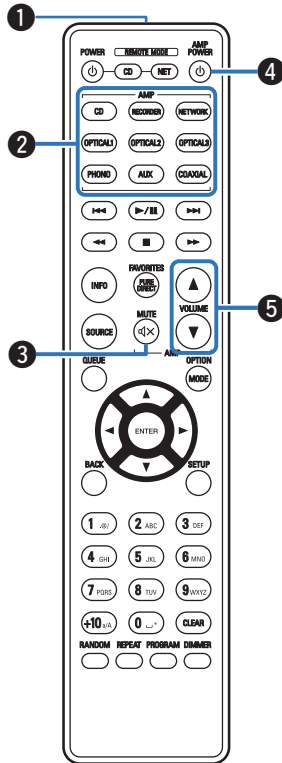

The included remote control can be used to operate not only this unit but other Denon CD players and network audio players too.

- “CD player operations” (☞ p. 13)
- “Network audio player operations” (☞ p. 14)

### ■ Operating this unit

#### 1 Remote control signal transmitter

This transmits signals from the remote control unit. (☞ p. 5)

#### 2 Input source select buttons

This selects the input source. (☞ p. 26)

#### 3 MUTE button (☞)

This mutes the output audio. (☞ p. 27)

#### 4 Power operation button (AMP POWER ⏻)

This turns the power on/off (standby).  
(☞ p. 25)

#### 5 VOLUME buttons (▲▼)

These adjust the volume level. (☞ p. 26)



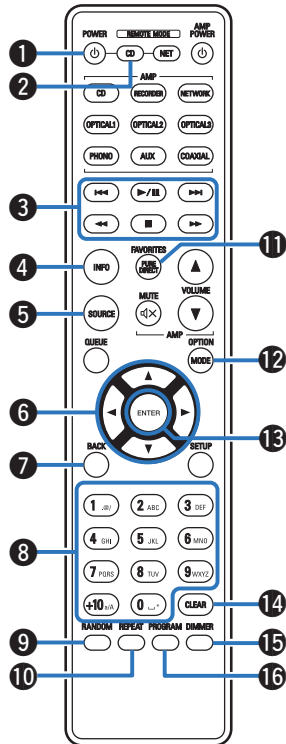

## CD player operations

A Denon CD player can be operated.

To operate a CD player, press the REMOTE MODE CD button to switch the remote control to the CD player operation mode.

- 1 Power operation button (POWER  $\phi$ )
- 2 Remote mode select button (REMOTE MODE CD)
- 3 System buttons
- 4 Information button (INFO)
- 5 SOURCE button
- 6 Cursor buttons ( $\Delta \nabla \triangleleft \triangleright$ )
- 7 BACK button
- 8 Number/letter buttons (0 - 9, +10)
- 9 RANDOM button
- 10 REPEAT button
- 11 PURE DIRECT button
- 12 MODE button
- 13 ENTER button
- 14 CLEAR button
- 15 DIMMER button
- 16 PROGRAM button



- The remote control may not operate some products.



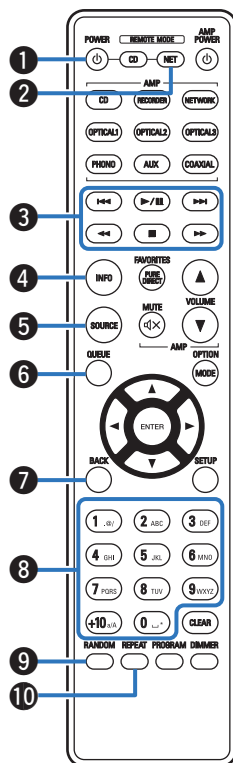

## ■ Network audio player operations

You can operate a Denon network audio player.

To operate a network audio player, press the REMOTE MODE NET button to switch the remote control to the network audio player operation mode.

- 1 Power operation button (POWER  $\phi$ )
- 2 Remote mode select button (REMOTE MODE NET)
- 3 System buttons
- 4 Information button (INFO)
- 5 SOURCE button
- 6 QUEUE button
- 7 BACK button
- 8 Number/letter buttons (0 – 9, +10)
- 9 RANDOM button
- 10 REPEAT button



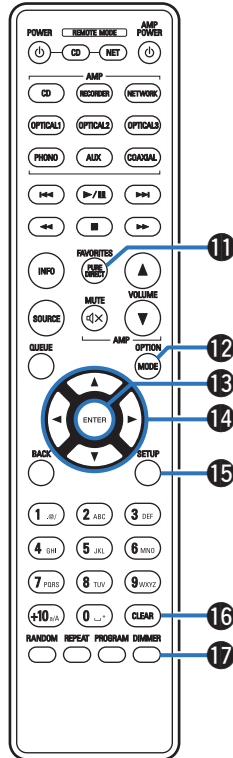

- 11 FAVORITES button
- 12 OPTION button
- 13 ENTER button
- 14 Cursor buttons ( $\Delta \nabla \triangleleft \triangleright$ )
- 15 SETUP button
- 16 CLEAR button
- 17 DIMMER button



- The remote control may not operate some products.



## ■ Contents

Connecting speakers	17
Connecting a playback device	20
Connecting a recording device	21
Connecting to a device with digital audio output connectors	22
Connecting the power cord	23

### NOTE

- Do not plug in the power cord until all connections have been completed.
- Do not bundle power cords together with connection cables. Doing so can result in humming or noise.

## ■ Cables used for connections

Provide necessary cables according to the devices you want to connect.

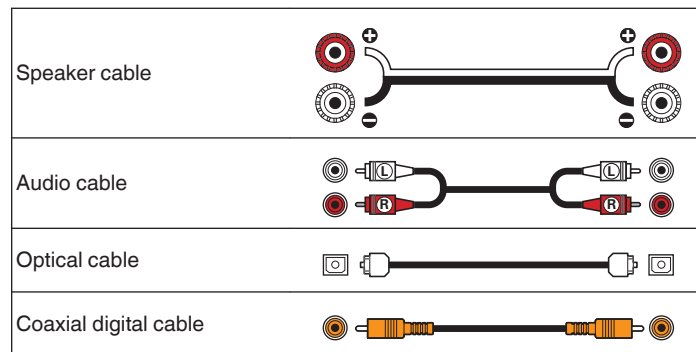



# Connecting speakers

## NOTE

- Disconnect this unit's power plug from the power outlet before connecting the speakers.
- Connect so that the speaker cable core wires do not protrude from the speaker terminal. The protection circuit may be activated if the core wires touch the rear panel or if the + and - sides touch each other. ("Protection circuit" (p. 41))
- Never touch the speaker terminals while the power cord is connected. Doing so could result in electric shock.
- Use speakers with impedances within the ranges shown below to suit how they are used.

Speaker terminals used on this unit	No. of connected speakers	Speaker Impedance
<b>SPEAKER SYSTEMS A (Standard connection)</b>	2 (one set)	4 – 16 Ω/ohms
<b>SPEAKER SYSTEMS B</b>	2 (one set)	4 – 16 Ω/ohms
<b>SPEAKER SYSTEMS A and B</b>	4 (two sets)	8 – 16 Ω/ohms
<b>SPEAKER SYSTEMS A and B (Bi-wiring connection)</b>	2 (one set)	4 – 16 Ω/ohms

## ■ Connecting the speaker cables

Carefully check the left (L) and right (R) channels and + (red) and – (black) polarities on the speakers being connected to this unit, and be sure to connect the channels and polarities correctly.

- 1 Peel off about 3/8 inch (10 mm) of sheathing from the tip of the speaker cable, then either twist the core wire tightly or terminate it.**



- 2 Turn the speaker terminal counterclockwise to loosen it.**



- 3 Insert the speaker cable's core wire to all the way into the speaker terminal.**

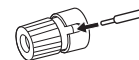

- 4 Turn the speaker terminal clockwise to tighten it.**



## Speaker connection

This unit is equipped with two sets of speaker terminals (SPEAKER SYSTEMS A and B). One set of speakers can be connected to each set of terminals, and a total of two sets of speakers can be connected.

The same signal is output from the SPEAKER SYSTEMS A and B terminals.

When only one set of speakers is to be connected, use either the SPEAKER SYSTEMS A or B terminals.

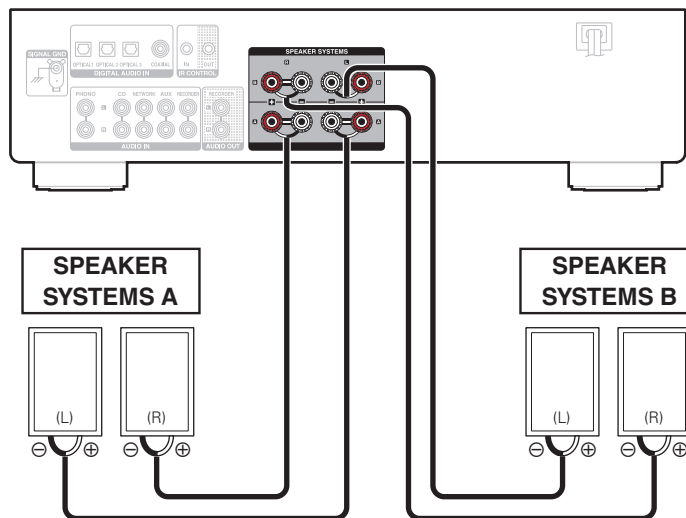

- You can use the SPEAKERS A and SPEAKERS B buttons on this unit to set which speaker terminals are to be used to output audio. Set according to the speakers connected to this unit. (👉 p.26)



## Bi-wiring connection

This connection limits the effects of signal interference between the high range speakers (tweeters) and low range speakers (woofers), allowing you to enjoy high quality playback.

When bi-wiring with bi-wireable speakers, connect the mid and high range terminals to SPEAKER SYSTEMS A (or B), the low range terminals to SPEAKER SYSTEMS B (or A).

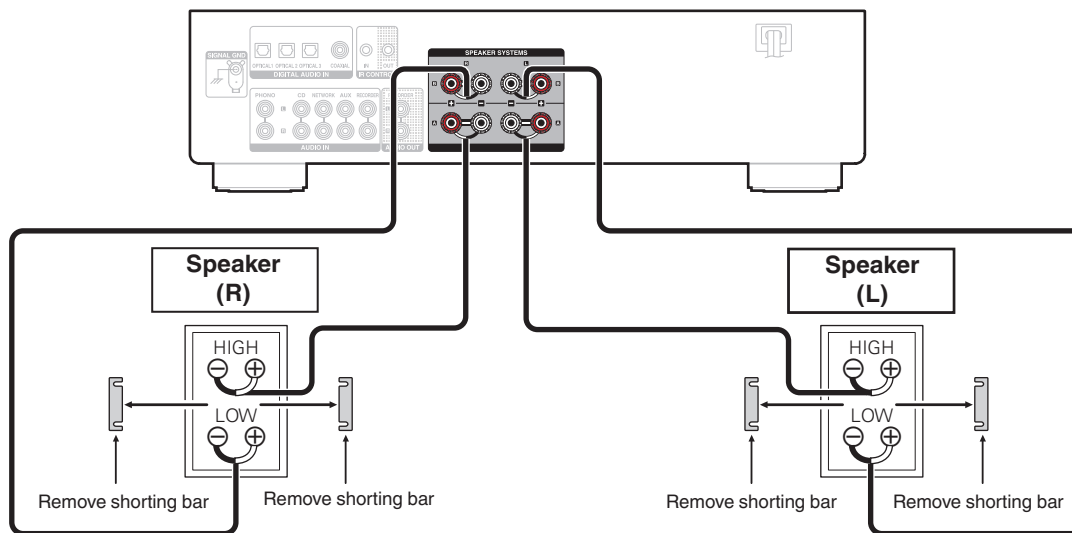

- When using bi-wiring connections, switch both the SPEAKERS A and SPEAKERS B buttons on this unit “ON (●)” to output audio from both SPEAKER SYSTEMS A and SPEAKER SYSTEMS B speaker terminals. (📖 p. 26)



## Connecting a playback device

You can connect turntables, CD players, network audio players and Blu-ray Disc players to this unit.

If you set this unit's input source to "PHONO" and you accidentally increase the volume without having a turntable connected, you may hear a hum noise from the speakers.

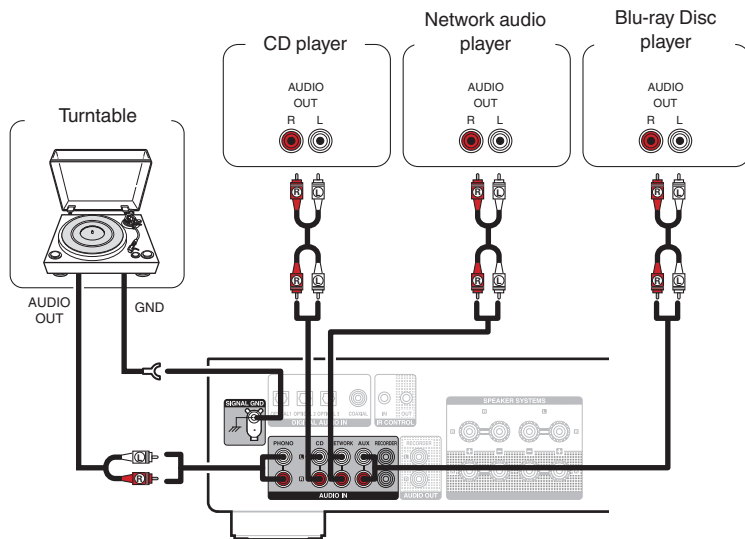

### NOTE

- The earth terminal (SIGNAL GND) of this unit is not for safety grounding purposes. If this terminal is connected when there is a lot of noise, the noise can be reduced. Note that depending on the turntable, connecting the ground line may have the reverse effect of increasing noise. In this case, it is not necessary to connect the ground line.



- The PHONO input terminals are equipped with a short pin-plug. Remove this plug to connect a record player. Store the removed short pin-plug in a safe place so as not to lose it.



## Connecting a recording device

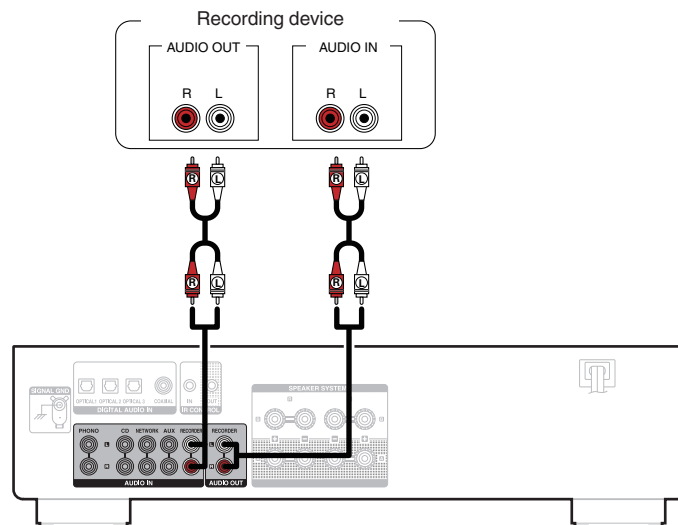

### NOTE

- Never insert the short-circuiting pin plug into the RECORDER output connectors. Doing so could result in damage.



## Connecting to a device with digital audio output connectors

Use this connection to input digital audio signals to this unit, and convert the signals for playback using the D/A converter of this unit. (🔍 p. 29)

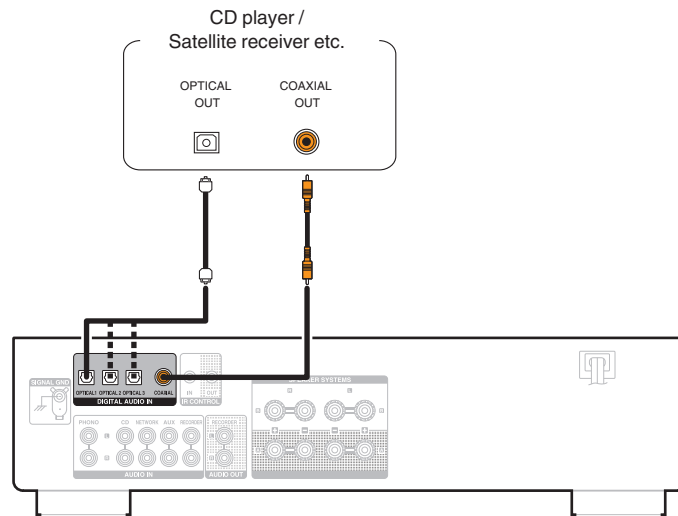

### NOTE

- Linear PCM signals with a sampling frequency of 32 kHz, 44.1 kHz, 48 kHz, 88.2 kHz, 96 kHz, 176.4 kHz, or 192 kHz can be input into this device.
- Do not input non-PCM signals, such as Dolby Digital, DTS and AAC. This causes noise and could damage the speakers.



## Connecting the power cord

After completing all the connections, insert the power plug into the power outlet.

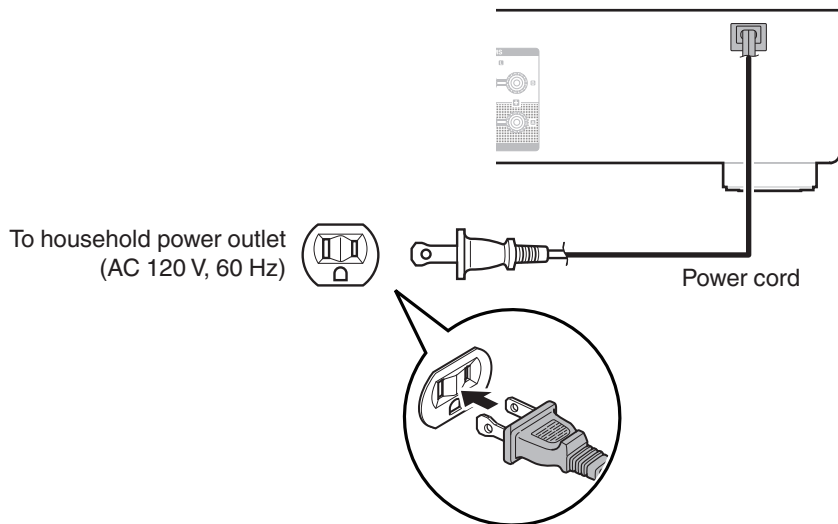

## ■ Contents

Turning the power on	25
Switching the power to standby	25
Selecting the speakers for audio output	26
Selecting the input source	26
Adjusting the volume	26
Turning off the sound temporarily (Muting)	27
Adjusting the tone	27
Playing CDs	27
Connecting and playing back from a digital device (Coaxial/ Optical)	29
Recording	30





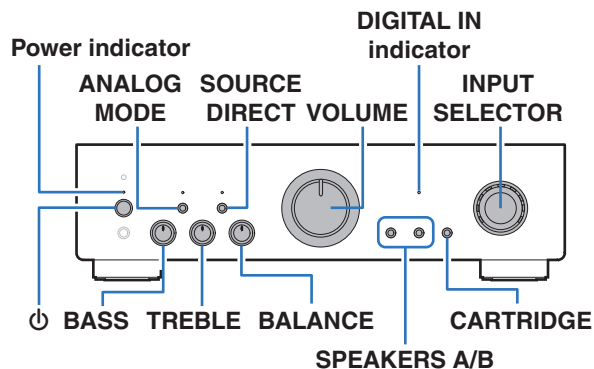
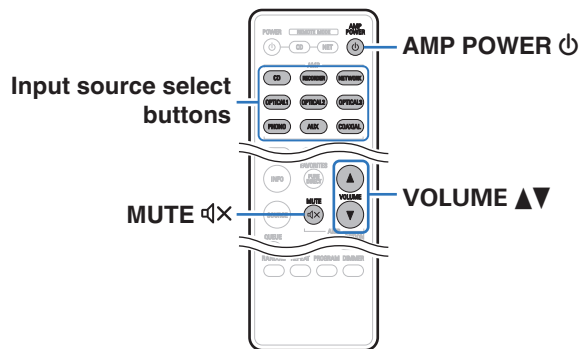

## Turning the power on

- 1 Press on the main unit to turn the power on.  
The power indicator lights green.



- Press AMP POWER on the remote control unit to turn on power from standby mode.

### NOTE

- Turn VOLUME on the main unit to adjust the volume to the lowest level before turning on the power.

## Switching the power to standby

- 1 Press AMP POWER .
- The unit switches to standby mode.

### NOTE

- Power continues to be supplied to some of the circuitry even when the power is in the standby mode. When leaving home for long periods of time or when going on vacation, either press on the main unit to turn off the power, or unplug the power cord from the power outlet.



## Selecting the speakers for audio output

- 1 Use **SPEAKERS A/B** on the main unit to select the speaker system to be used for playback.



- If either **SPEAKERS A** or **SPEAKERS B** is “ON (●)”, audio is output from the associated speaker terminals.
- If both **SPEAKERS A** and **SPEAKERS B** are “ON (●)”, audio is output from both of the speaker terminals. When using bi-wiring connections, turn both **SPEAKERS A** and **SPEAKERS B** “ON (●)”.
- If both **SPEAKERS A** and **SPEAKERS B** are “OFF (■)”, no audio is output from the speaker terminals. Turn **SPEAKERS A** and **SPEAKERS B** “OFF (■)” when using headphones.

## Selecting the input source

- 1 Press the input source select button to be played back.  
The indicator of the selected input source lights.



- You can also select the input source by turning **INPUT SELECTOR** on the main unit.

## Adjusting the volume

- 1 Use **VOLUME ▲▼** to adjust the volume.



- You can also adjust the volume by turning **VOLUME** on the main unit.



## Turning off the sound temporarily (Muting)

- 1 Press **MUTE** .  
The power indicator flashes green.



- To cancel mute, press **MUTE**  again.

## Adjusting the tone

- 1 Press **SOURCE DIRECT** on the main unit to turn off **source direct mode**.  
The **SOURCE DIRECT** indicator turns off.
- 2 Turn the **BASS**, **TREBLE** and **BALANCE** to adjust the tone.

## Playing CDs

This section uses playback from a CD as an example.

- 1 Press the **input source select button (CD)** to switch the **input source to “CD”**.  
The “CD” input indicator lights.
- 2 **Playback the CD.**
- 3 Use **VOLUME ▲▼** to adjust the volume.



## ■ Playback in source direct mode

The signal does not pass through the tone adjustment circuitry (BASS, TREBLE and BALANCE), resulting in playback of a higher sound quality.

### 1 Press SOURCE DIRECT on the main unit to turn on source direct mode.

The SOURCE DIRECT indicator lights.

## ■ Playback in analog mode

If analog mode is turned on when playing back an analog input source (PHONO, CD, NETWORK, AUX, RECORDER), power to the digital input circuit is turned off. This prevents the analog signal circuit from being affected by noise generated by the digital control circuit, resulting in high quality audio playback.

### 1 Press ANALOG MODE on the main unit to turn analog mode on.

ANALOG MODE indicator lights.

- Analog mode switches on or off each time the button is pressed.

<b>Analog mode on:</b>	Turns the digital input circuit power off.
<b>Analog mode off:</b>	Analog mode is not used.



- A digital input source (COAXIAL, OPTICAL 1/2/3) cannot be selected when analog mode is on.
- The input source automatically switches to "CD" if analog mode is turned on during playback of a digital input source (COAXIAL, OPTICAL 1/2/3).
- When the analog mode is switched, the mute circuit is activated for about 5 seconds.



## Connecting and playing back from a digital device (Coaxial/Optical)

- 1 Connect digital device to this unit.** (🔧 p. 22)
- 2 Press the input source select button (COAXIAL, OPTICAL 1, OPTICAL 2 or OPTICAL 3) to switch the input source to “COAXIAL”, “OPTICAL 1”, “OPTICAL 2” or “OPTICAL 3”.**

The indicator of the selected input source lights.

- 3 Start playback of the digital device connected to this unit.**

DIGITAL AUDIO IN indicator lights.



- The DIGITAL AUDIO IN indicator blinks when audio signals that are not supported by this unit are input.
- If the sampling frequency cannot be detected, the DIGITAL AUDIO IN indicator turns off.

### ■ Audio signals that can be played back

See “D/A converter” (🔧 p. 40).

#### NOTE

- Do not input non-PCM signals, such as Dolby Digital, DTS and AAC. This causes noise and could damage the speakers.
- If the sampling frequency switches, the sound may cut for 1 - 2 seconds.



## Recording

Audio signals input into this unit can be output to an external recording device. When recording audio from a playback device connected to this unit, audio can be recorded with the playback device still connected to this unit.

- 1 Press  on the main unit to turn the power on.**
- 2 Press the input source select button to switch to the input source from which you want to record.**

The indicator of the selected input source lights.

- 3 Recording starts.**

- For information on operations, see the owner's manual of the recording device.



## Setting the Auto Standby mode

You can set the unit to automatically switch to standby mode if the unit is not operated for 30 minutes when there is no audio input (Auto Standby mode).

Auto Standby mode is set to off by default.



### Turning Auto Standby mode on

- 1 Press and hold **AMP POWER**  for more than 5 seconds to turn the Auto Standby mode on.

The power indicator flashes green three times.

### Turning Auto Standby mode off

- 1 Press and hold **AMP POWER**  for more than 5 seconds to turn the Auto Standby mode off.

The power indicator flashes green once.



## ■ Contents

### Tips

I want to adjust the tone myself	33
I want sound playback that is faithful to the original sound	33
I want to enjoy higher sound quality from the analog input source	33
I want to use bi-wiring compatible speakers	33

### Troubleshooting

Power does not turn on / Power is turned off	35
Operations cannot be performed through the remote control unit	36
No sound comes out	37
Desired sound does not come out	37
Sound is interrupted or noise occurs	38
Audio from digital devices cannot be played back (Coaxial/Optical)	39





# Tips

---

## I want to adjust the tone myself

- Use the BASS, TREBLE and BALANCE knobs to adjust the sound as desired. (👉 p. 27)

## I want sound playback that is faithful to the original sound

- Set the source direct mode on. (👉 p. 28)

## I want to enjoy higher sound quality from the analog input source

- Set the analog mode on. (👉 p. 28)

## I want to use bi-wiring compatible speakers

- This unit is compatible with bi-wiring connections. Enjoy high quality playback by using bi-wiring connections. (👉 p. 19)



# Troubleshooting

---

If a problem should arise, first check the following:

1. **Are the connections correct?**
2. **Is the set being operated as described in the owner's manual?**
3. **Are the other devices operating properly?**

If this unit does not operate properly, check the corresponding symptoms in this section.

If the symptoms do not match any of those described here, consult your dealer as it could be due to a fault in this unit. In this case, disconnect the power immediately and contact the store where you purchased this unit.



## Power does not turn on / Power is turned off

### Power is not turned on.

- Check whether the power plug is correctly inserted into the power outlet. (🔍 p. 23)

### Power automatically turns off.

- The Auto Standby mode setting is on. The Auto Standby mode switches the unit to standby mode when there is no audio input and the unit is not operated for approximately 30 minutes. Press and hold the AMP POWER ⏻ button for more than 5 seconds when in Auto Standby mode to cancel Auto Standby mode. (🔍 p. 31)

### Power turns off and the power indicator flashes in red approx. every 0.5 seconds.

- The protection circuit has been activated due to a rise in temperature within this unit. Turn the power off, wait about an hour until this unit cools down sufficiently, and then turn the power on again. (🔍 p. 41)
- Please re-install this unit in a place having good ventilation.

### Power turns off and the power indicator flashes in red approx. every 0.25 seconds.

- Check the speaker connections. The protection circuit may have been activated because speaker cable core wires came in contact with each other or a core wire was disconnected from the connector and came in contact with the rear panel of this unit. After unplugging the power cord, take corrective action such as firmly re-twisting the core wire or taking care of the connector, and then reconnect the wire. (🔍 p. 17)
- Turn down the volume and turn on the power again. (🔍 p. 25)

### When the power is turned on, the power indicator flashes in red approx. every 0.25 seconds.

- This unit's amplifier circuit has failed. Unplug the power cord and contact our customer service center.



## Operations cannot be performed through the remote control unit

### Operations cannot be performed through the remote control unit.

- Batteries are worn out. Replace with new batteries. (🔍 p. 5)
- Operate the remote control unit within a distance of about 23 ft/7 m from this unit and at an angle of within 30°. (🔍 p. 5)
- Remove any obstacle between this unit and the remote control unit.
- Insert the batteries in the proper direction, checking the ⊕ and ⊖ marks. (🔍 p. 5)
- The set's remote control sensor is exposed to strong light (direct sunlight, inverter type fluorescent bulb light, etc.). Move the set to a place in which the remote control sensor will not be exposed to strong light.
- When using a 3D video device, the remote control unit of this unit may not function due to effects of infrared communications between units (such as TV and glasses for 3D viewing). In this case, adjust the direction of units with the 3D communications function and their distance to ensure they do not affect operations from the remote control unit of this unit.



## No sound comes out

### No sound comes out of speakers.

- Check the connections for all devices. (🔧 p. 16)
- Insert connection cables all the way in.
- Check that input connectors and output connectors are not reversely connected.
- Check cables for damage.
- Check that speaker cables are properly connected. Check that cable core wires come in contact with the metal part on speaker terminals. (🔧 p. 17)
- Securely tighten the speaker terminals. Check speaker terminals for looseness. (🔧 p. 17)
- Check that the proper input source is selected. (🔧 p. 26)
- The volume is set to the minimum level. Adjust the volume to a suitable level. (🔧 p. 26)
- Cancel the muting mode. (🔧 p. 27)
- Check the settings of the SPEAKERS A/B buttons. (🔧 p. 26)

## Desired sound does not come out

### No sound comes out of a specific speaker.

- Check that speaker cables are properly connected. (🔧 p. 17)
- Adjust the BALANCE control knob. (🔧 p. 27)

### The left and right of stereo sound is reversed.

- Check whether the left and right speakers are connected to the correct speaker terminals. (🔧 p. 17)



## Sound is interrupted or noise occurs

### When playing a record, the sound is distorted.

- Adjust to a proper needle pressure.
- Check the tip of the needle.
- Replace the cartridge.

### When playing a record, a humming noise comes out of the speakers.

- Check that the turntable is connected correctly. (🔍 p. 20)
- If there is a TV or AV device near the turntable, such devices may affect the playback sound. Install the turntable in a location as far away as possible from the TV or other AV devices.

### When playing a record, a humming noise comes out of the speakers when the volume is high. (Howling phenomenon)

- Install the turntable and speakers as far from each other as possible. (🔍 p. 20)
- The vibrations from the speakers are being transmitted to the player through the floor. Use cushions, etc., to absorb the speakers' vibrations.



## Audio from digital devices cannot be played back (Coaxial/Optical)

### **DIGITAL AUDIO IN indicator is off.**

- When digital audio signals cannot be detected properly, the DIGITAL AUDIO IN indicator is off. (👉 p. 29)

### **DIGITAL AUDIO IN indicator is flashing.**

- The DIGITAL AUDIO IN indicator blinks when audio signals that are not supported by this unit are input. Check the audio output signal format from your digital device. (👉 p. 29)



## D/A converter

---

### ■ Specifications of supported audio signals

#### □ Coaxial/Optical

	Sampling frequency	Bit length
Linear PCM (2-channel)	32/44.1/48/88.2/96/ 176.4/192 kHz	16/24 bits

## Explanation of terms

---

### Sampling frequency

Sampling involves taking a reading of a sound wave (analog signal) at regular intervals and expressing the height of the wave at each reading in digitized format (producing a digital signal).

The number of readings taken in one second is called the “sampling frequency”. The larger the value, the closer the reproduced sound is to the original.

### Linear PCM

This is an uncompressed PCM (Pulse Code Modulation) signal. This is the same system used for CD audio but uses 192 kHz, 96 kHz, and 48 kHz sampling frequencies on Blu-ray Disc or DVD and provides higher resolution than CD.





**Speaker impedance**

This is an AC resistance value, indicated in  $\Omega$  (ohms).

Greater power can be obtained when this value is smaller.

**Source direct**

Playback with higher fidelity to the source becomes possible, as input audio signals are output by bypassing the audio quality-control circuits (BASS/TREBLE/BALANCE).

**Protection circuit**

This is a function to prevent damage to devices within the power supply when an abnormality such as an overload, excess voltage occurs or over temperature for any reason.

## Trademark information



Adobe, the Adobe logo and Reader are either registered trademarks or trademarks of Adobe Systems Incorporated in the United States and/or other countries.



# Specifications

---

## ■ Power amplifier section

<b>Rated Output Power:</b>	2-channel driving (CD → SP OUT) 50 W + 50 W (8 Ω/ohms, 20 Hz - 20 kHz, T.H.D. 0.07 %) 85 W + 85 W (4 Ω/ohms, 1 kHz, T.H.D. 0.7 %)
<b>Total harmonic distortion:</b>	0.01 % (Rated output: -3 dB), 8 Ω/ohms, 1 kHz
<b>Output terminals:</b>	Speaker A or B: 4 – 16 Ω/ohms Speaker A + B: 8 – 16 Ω/ohms Suited for headphones/stereo headphones

## ■ Pre amplifier section

<b>Input Sensitivity/Input Impedance:</b>	PHONO (MM): 2.5 mV / 47 kΩ/kohms PHONO (MC): 200 μV / 100 Ω/ohms CD, NETWORK, AUX, RECORDER: 105 mV / 40 kΩ/kohms (SOURCE DIRECT: Off) 105 mV / 17 kΩ/kohms (SOURCE DIRECT: On)
<b>RIAA Deviation:</b>	PHONO: 20 Hz – 20 kHz ±0.5 dB
<b>Maximum Input:</b>	PHONO (MM): 70 mV / 1 kHz PHONO (MC): 6 mV / 1 kHz



## ■ Overall performance

<b>SN Ratio (A network):</b>	PHONO (MM): 86 dB (With input terminals short-circuited, 5 mV input signal) PHONO (MC): 71 dB (With input terminals short-circuited, 0.5 mV input signal) CD, NETWORK, AUX, RECORDER: 105 dB (input terminals short-circuited)
<b>Frequency response:</b>	5 Hz – 100 kHz (0 – -3 dB)
<b>Tone control:</b>	BASS: 100 Hz $\pm$ 8 dB TREBLE: 10 kHz $\pm$ 8 dB

### • Digital input signal format

<b>Format:</b>	Digital audio interface (Linear PCM)
<b>Coaxial input:</b>	0.5 V <sub>p-p</sub> / 75 $\Omega$ /ohms
<b>Optical input:</b>	More than -27 dBm
<b>Optical wavelength:</b>	660 nm

## ■ General

<b>Power supply:</b>	AC 120 V, 60 Hz
<b>Power consumption:</b>	200 W
<b>Power consumption in standby mode:</b>	0.3 W
<b>Operating temperature:</b>	+5 °C - +35 °C

For the purpose of improvement, the specifications and design are subject to change without notice.



## ■ Dimensions (Unit : in. (mm))

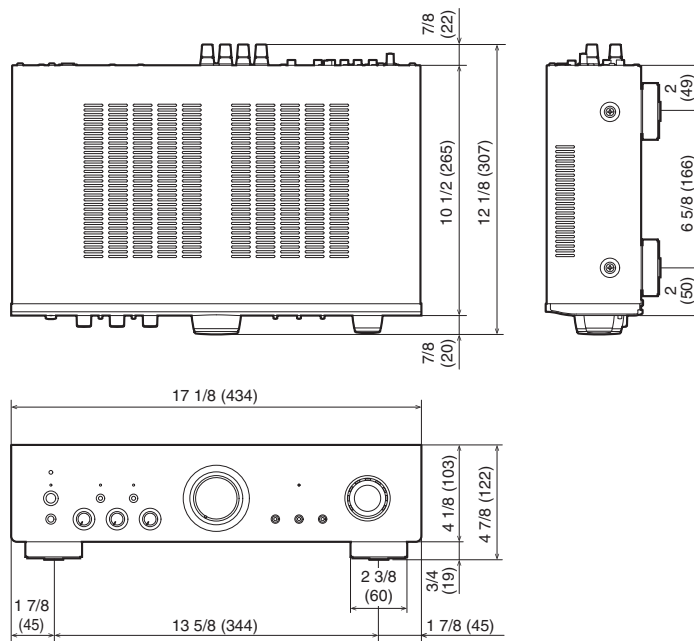

## ■ Weight : 16 lb 9 oz (7.5 kg)

# Index

<b>A</b>		<b>I</b>		<b>S</b>	
Auto Standby mode .....	31	Input source .....	26	Satellite receiver .....	22
<b>B</b>		<b>M</b>		Source direct .....	
BALANCE .....	27	Muting .....	27	27, 41	41
BASS .....	27	<b>N</b>		Speaker impedance .....	41
Bi-wiring .....	19	Network audio player .....	20	Speakers .....	17
Blu-ray Disc player .....	20	<b>P</b>		<b>T</b>	
<b>C</b>		Protection circuit .....		Tips .....	33
CD player .....	20, 22	41		Tone .....	27
<b>D</b>		<b>R</b>		TREBLE .....	27
D/A Converter .....	40	Recording device .....		Troubleshooting .....	34
		Remote control unit .....		Turntable .....	20
		12		<b>V</b>	
				Volume .....	26



**DENON<sup>®</sup>**

[www.denon.com](http://www.denon.com)

3520 10632 10AD

Copyright © 2018 D&M Holdings Inc. All Rights Reserved.