

DENON[®]

CEOL carino

Computer Audio System N-2

Owner's Manual

You can print more than one page of a PDF onto a single sheet of paper.

[Front panel](#)[Display](#)[Rear panel](#)[Remote](#)[Index](#)

Accessories	4
Before using the remote control unit	5
Operating range of the remote control unit	6
Features	7
Part names and functions	8
Front panel	8
Display	10
Rear panel	11
Remote control unit	12

Connections

Installing this unit	13
Installing horizontally	13
Installing vertically	14
Speaker installation	15
Connecting the speaker cables	16
Storing speaker cables in the speaker base	17
Connecting devices	18
Connecting the power cord	19

Playback

Basic operation	21
Turning the power on	21
Selecting the input source	22
Adjusting the master volume	22
Playing a device	23
Playing music on a computer (USB-DAC)	23
Listening to music via a analog connection (ANALOG IN)	25
Listening to music on a Bluetooth device	26
Convenient function menu	32
Wide Sound function	32
Auto Volume Adjust function	32

Setting procedure

Setting the auto standby mode	33
Turning the auto standby mode off	33
Turning the auto standby mode on	33
Turning the display on/off	33
Turning the display off	33
Turning the display on	33



Tips

Tips	35
Troubleshooting	36
Resetting to factory settings	41

Appendix





Types of playable digital audio input signals	42
Audio signals that can be input to USB-DAC	42
Playing back Bluetooth devices	42
Bluetooth communications	42
Explanation of terms	43
Trademark information	44
Specifications	45
Index	48

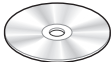
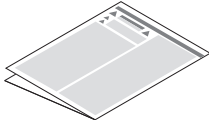
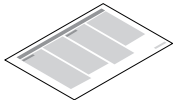
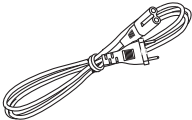
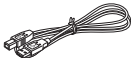

Thank you for purchasing this Denon product. To ensure proper operation, please read this owner's manual carefully before using the product. After reading this manual, be sure to keep it for future reference.

Accessories

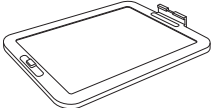
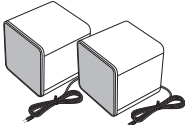
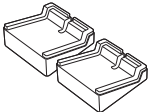
Check that the following parts are supplied with the product.

 <p>Quick Start Guide</p>	 <p>CD-ROM (Owner's Manual)</p>	 <p>Safety Instructions</p>	 <p>Notes on radio</p>
 <p>Power cord</p>	 <p>USB cable (cable length: 1.2 m)</p>	 <p>Remote control unit (RC-1195) (built-in battery)</p>	 <p>CEOL carino base</p>
 <p>Speakers (x2) (cable length: 1.5 m)</p>	 <p>Speaker bases (x2)</p>	 <p>Cable winders (x2)</p> <ul style="list-style-type: none"> • Stored under the speaker bases at the time of shipment. 	



Before using the remote control unit

The remote control unit has a built-in lithium battery.
Pull out the insulation sheet before use.

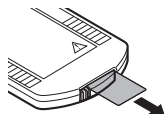

NOTE

- When inserting the lithium battery, be sure to do so in the proper direction, following the ⊕ and ⊖ marks in the battery compartment.
- If the battery should have a leakage, immediately replace and dispose of the battery. In this case, there is a risk of burn when the liquid comes in contact with skins or clothes, so a great care should be taken. If the liquid accidentally comes in contact, wash with tap water and consult a doctor.
- Remove the battery from the remote control unit if it will not be in use for long periods.

■ Replacing the battery

1. Pull out the battery case while pressing the tab.

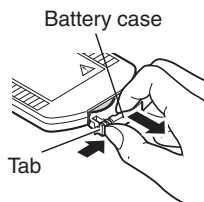

2. Insert the lithium battery correctly into the battery compartment as indicated.

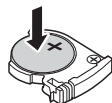

3. Replace the battery case in the original position.



Operating range of the remote control unit

Point the remote control unit at the remote sensor when operating it.

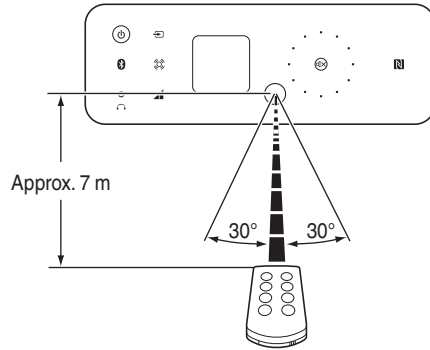

Features

- **Powerful sound with a compact body (25W + 25W high power)**

You can enjoy music and games with more powerful sound on a computer, smartphone, or tablet. Realistic sound is achieved in spite of the compact size by combining passive radiator full range speakers that reproduce rich bass with our unique audio processing technology and a full digital amplifier.

- **Installation possible even in a small space (🔧 p. 13)**

This unit can be placed either horizontally or vertically. Do not worry about the installation place. You can place this unit even in a desk with a limited space. Furthermore, convenient speaker bases are supplied with this unit for altering the speaker angle. Adjust to your desired angle for listening.

- **Equipped with a USB-B port for upgrading audio on a computer**

You can just connect a computer with this unit to enjoy content stored on the computer and streaming content with high quality audio.

- **Wireless connection with Bluetooth enabled devices (🔧 p. 26)**

You can connect Bluetooth enabled devices such as smartphones and tablets with this unit to listen to music while browsing email and Web sites in the Internet away from this unit. In addition, this unit supports high quality audio codecs, aptX and AAC, to enjoy music and games with a powerful sound.

- **NFC function included that enables one touch connection (🔧 p. 30)**

You can just touch this unit with an NFC enabled smartphone or tablet to turn on power to this unit and establish the Bluetooth connection.



Part names and functions

Front panel

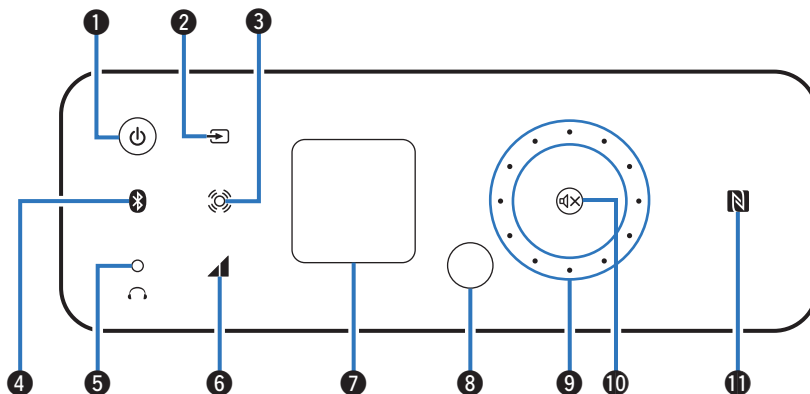

① Power button/display (⏻)

This turns the power on/to standby. (☞ p. 21)

The power status is indicated as follows.

- Power on: Lit
- Standby: Off

② Input source switching key (⏮)

This switches input sources. (☞ p. 22)

③ Wide Sound key (🔊)

This switches the Wide Sound function on/off. (☞ p. 32)

④ Bluetooth key (📶)

This switches the input to Bluetooth. This is also touched during the pairing operation. (☞ p. 27)



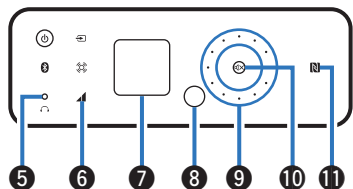

5 Headphones jack (🎧)

Used to connect headphones.

When the headphones are plugged into this jack, audio will no longer be output from the speaker terminals.

NOTE

To prevent hearing loss, do not raise the volume level excessively when using headphones.

6 Auto Volume Adjust key (🔊)

This switches the Auto Volume Adjust function on/off. (👉 p. 32)

7 Display

This displays various pieces of information.

8 Remote control sensor

This receives signals from the remote control unit. (👉 p. 6)

9 Volume adjustment wheel

This adjusts the volume level. (👉 p. 22)

The wheel is lit when touched.



The volume level appears on the display.

10 Mute button (🔇)

This mutes the output audio. (👉 p. 22)

This button flashes when muting is on.

11 N mark (N)

Touch this mark with a Bluetooth device that includes the NFC function when pairing (registering) with it. (👉 p. 30)



Display

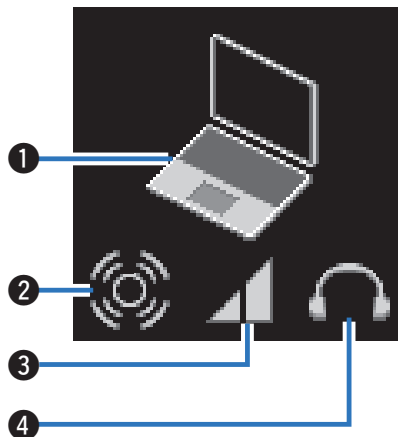

1 Input source indicator

The following is displayed depending on the selected input source.

USB-DAC	ANALOG IN	Bluetooth
		

2 Wide Sound indicator

Lit when the Wide Sound function is on.

3 Auto Volume Adjust indicator

Lit when the Auto Volume Adjust function is on.

4 Headphones indicator

Lit when the headphones are used.



Rear panel

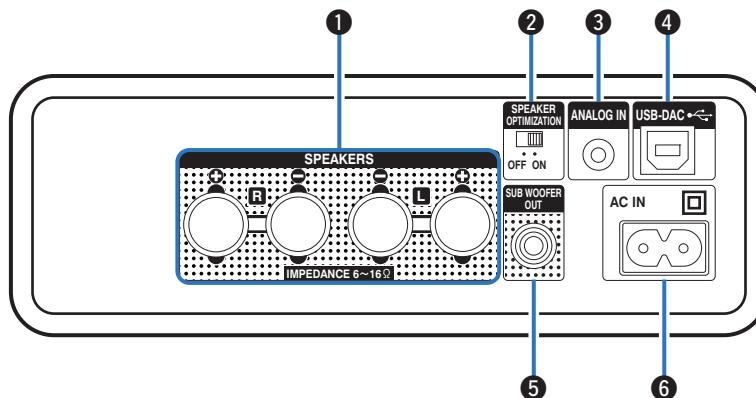

❶ Speaker terminals (SPEAKERS)

Used to connect speakers. (🔗 p. 17)

❷ Speaker Optimization switch (SPEAKER OPTIMIZATION)

This switches the Speaker Optimization function on/off. (🔗 p. 17)

❸ Analog audio input terminal (ANALOG IN)

Use a stereo mini plug cable (sold separately) to connect between this terminal and a headphones jack on a portable music player, etc.

(🔗 p. 18)

❹ USB digital audio input terminal (USB-DAC 🔄)

Used to connect to a computer with a USB port. (🔗 p. 18)

❺ Subwoofer terminal (SUB WOOFER OUT)

Used to connect a subwoofer with a built-in amplifier. (🔗 p. 18)

❻ AC inlet (AC IN)

Used to connect the supplied power cord. (🔗 p. 19)



Remote control unit

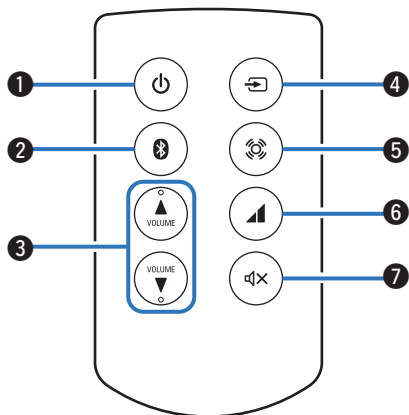

1 Power operation button (⏻)

This turns the power on/to standby. (☞ p. 21)

2 Bluetooth button (📶)

This switches the input to Bluetooth. This is also pressed during the pairing operation. (☞ p. 27)

3 VOLUME buttons (VOLUME ▲▼)

These adjust the volume level. (☞ p. 22)

4 Input source switching button (➡)

This switches input sources. (☞ p. 22)

5 Wide Sound button (🔊)

This switches the Wide Sound function on/off. (☞ p. 32)

6 Auto Volume Adjust button (🔊▲)

This switches the Auto Volume Adjust function on/off. (☞ p. 32)

7 Mute button (🔇)

This mutes the output audio. (☞ p. 22)



Installing this unit

This unit can be installed in two ways - horizontally or vertically. You can select how to install this unit according to the installation place and your preference.

Installing horizontally

This orientation is suitable for placing this unit under the monitor when you use a desktop computer.

When placing this unit horizontally, install as follows.

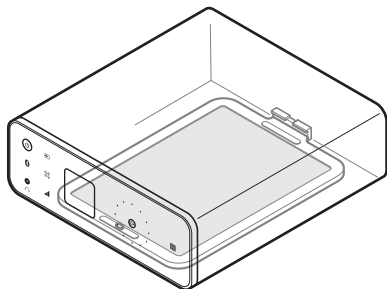

■ How to attach the CEOL carino base (for horizontal placement)

Attach the base to this unit as follows.

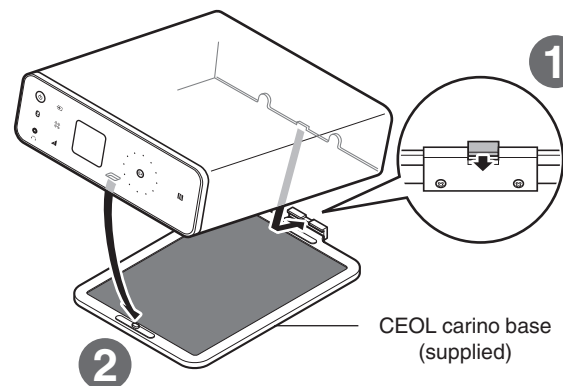

Installing vertically

This orientation is suitable for placing a narrow place such as a place next to a laptop computer.

When placing this unit vertically, install as follows with the power button placed on the lower part.

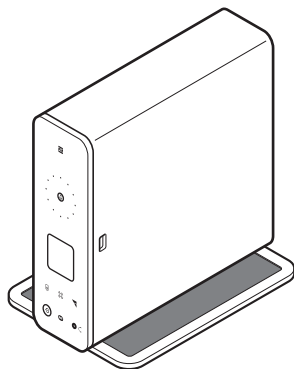

■ How to attach the CEOL carino base (for vertical placement)

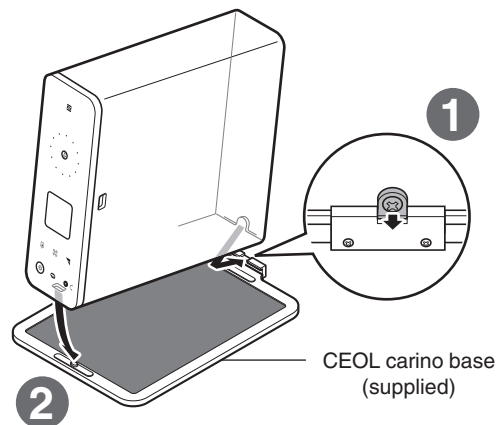

- To remove the base from this unit, follow the installation steps in the reverse order.



Speaker installation

You can use the speaker base to place the speaker in three angles. Adjust to your desired angle for placement.

NOTE

- You cannot remove the speaker net.
- Place the speaker and speaker base so that they do not rattle.

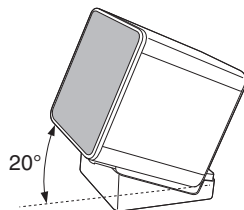
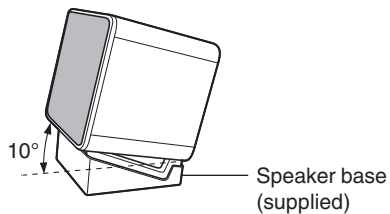
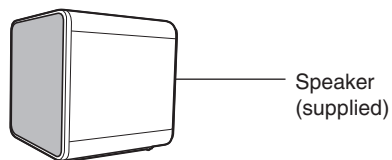

Connecting the speaker cables

Connect the speaker cable with a rubber tube (red) to the + speaker terminal (red), and the other cable to the - speaker terminal (black).

- 1 Peel off about 10 mm of sheathing from the tip of the speaker cable, then twist the core wire tightly.**



- 2 Push the speaker terminal and insert the speaker cable into the cable insertion slot.**

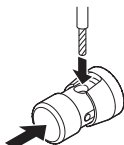

- 3 Release your finger from the speaker terminal to fix the speaker cable.**

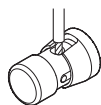

NOTE

Ensure that only the core wire part of the speaker cable is inserted. If the covered part is inserted, sound may not be output.



Storing speaker cables in the speaker base

You can use the cable winder to wind up the loose speaker cable for organized connections. Cable winders are stored under the speaker bases at the time of shipment.

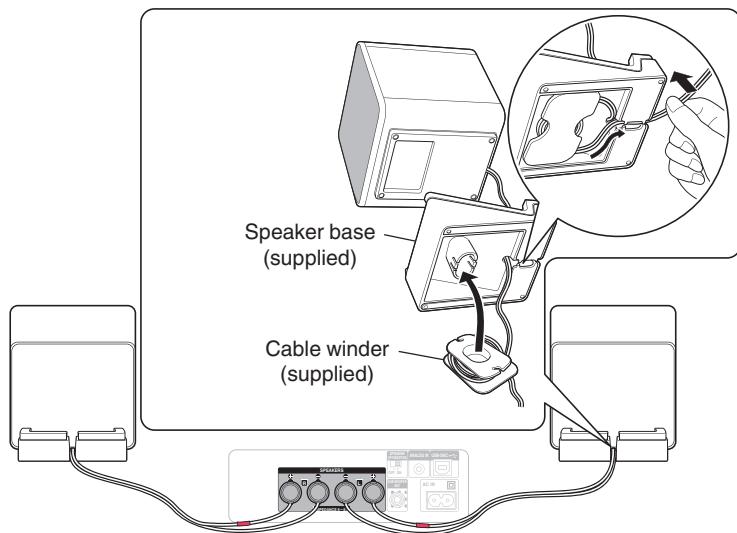

NOTE

- When using the supplied speakers, turn on the SPEAKER OPTIMIZATION switch on the rear panel. Audio signals are output after audio processing optimized for the supplied speakers.
- When using speakers other than the supplied ones, turn off the SPEAKER OPTIMIZATION switch on the rear panel. Audio signals are output for the playback source without any processing.
- Be careful not to have the speaker cable under the speaker base. Doing so may cause a rattle or abnormal sound.



Connecting devices

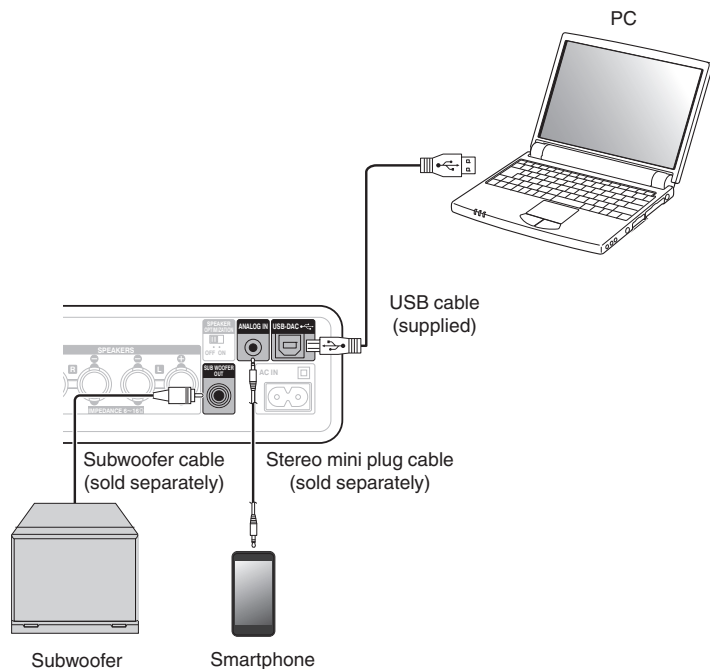

■ Computer (recommended system)

OS

- Windows® Vista, Windows 7, and Windows 8
- Mac OS X 10.6.3 or later

NOTE

Use a 3 m or less cable to connect to a computer.



Connecting the power cord

After completing all the connections, insert the power cord into the power outlet.

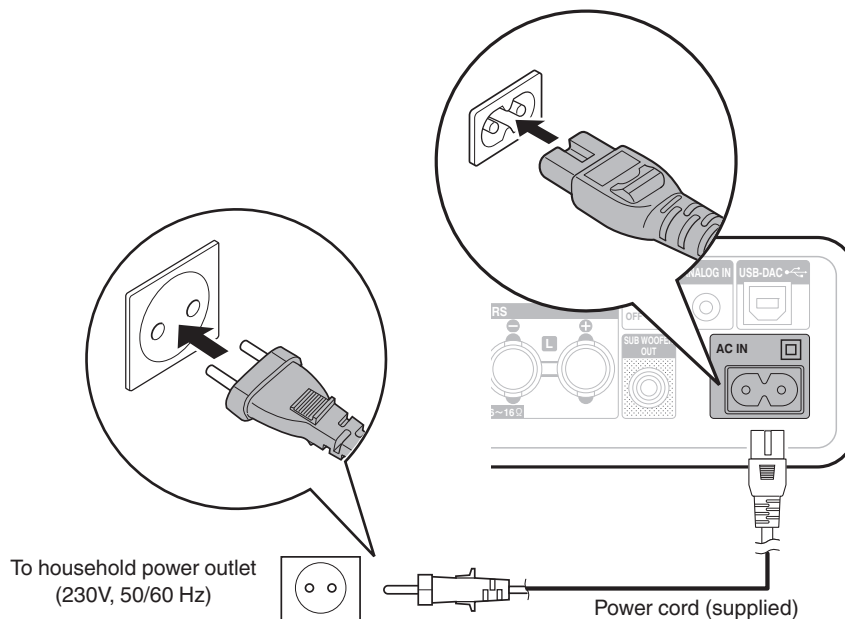

NOTE

Do not use a power cord other than the supplied one.



■ Contents

Basic operation

Turning the power on	21
Selecting the input source	22
Adjusting the master volume	22

Playing a device

Playing music on a computer (USB-DAC)	23
Listening to music via a analog connection (ANALOG IN)	25
Listening to music on a Bluetooth device	26

Convenient function menu

Wide Sound function	32
Auto Volume Adjust function	32



Basic operation

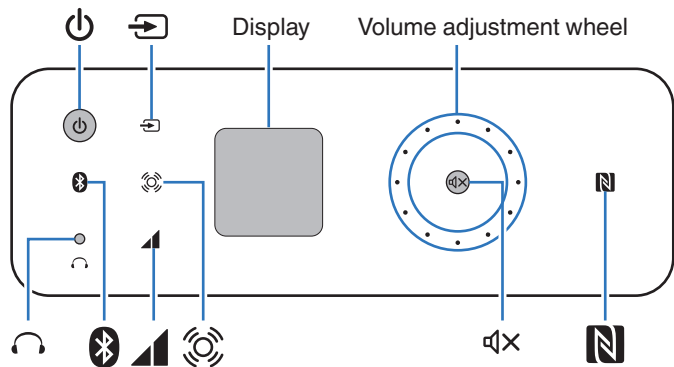

Turning the power on

- 1 Press **⏻** to turn on power to this unit.
The power indicator is lit.

Switching power to the standby mode

- 1 Press **⏻**.
The power indicator is turned off.



You can also press **⏻** on the remote control unit for this operation.

NOTE

When the power is in the standby mode, some circuits are electrified. Before you go out or travel for a long period of time, disconnect the power cord from the power outlet.



Selecting the input source

■ Selecting USB-DAC or ANALOG IN

- 1 Touch  to select the input source for playback.
The following icon appears on the display.



USB-DAC: Plays back audio on the computer.



ANALOG IN: Plays back the device connected to the ANALOG IN connector.



You can also press  on the remote control unit for this operation.

■ Selecting Bluetooth

- 1 Touch .
The following icon appears on the display.



Bluetooth: Connects and plays back a Bluetooth device.



You can also press  on the remote control unit for this operation.

Adjusting the master volume



- 1 Turn the volume adjustment wheel to adjust the volume level.

The volume level appears on the display.





Increasing the volume level: Turn the volume adjustment wheel clockwise.

Decreasing the volume level: Turn the volume adjustment wheel counterclockwise.



- You can also press VOLUME   on the remote control unit for this operation.
- You can adjust the volume level between 0 and 60.

■ Turning off the sound temporarily (muting)

- 1 Press .
 flashes and  appears on the display.
 - Press  again to cancel the muting.



You can also press  on the remote control unit for this operation.



Playing a device

Connect the device you want to play back beforehand. (“Connecting devices” (p. 18))

Playing music on a computer (USB-DAC)

- 1 Turn on power to the computer.
- 2 Press **⏻** to turn on power to this unit.
The power indicator is lit.
 - The driver is automatically installed on the computer.
- 3 Touch **⏻** to switch the input source to “USB-DAC”.
🔊 appears on the display.

4 Set the audio signal destination to this unit on the computer.

- This operation is required when you are playing back music on the computer for the first time.

[Windows]

- ① Select “CEOL carino” in the sound menu screen on the computer and click “Set Default”.

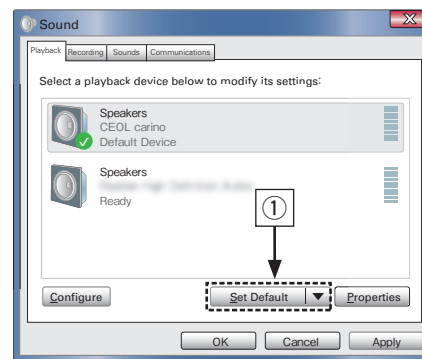

[Mac OS]

- ① Select “System Preferences” in the Apple menu and click “Sound”.

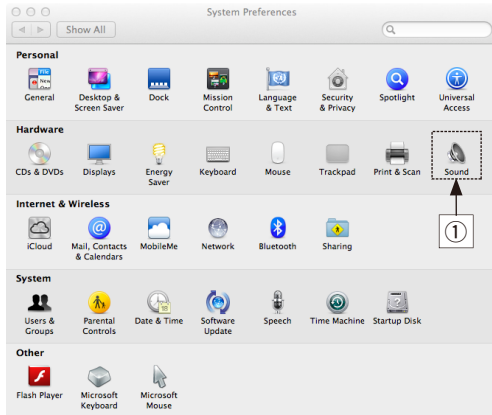

- ② Click “Output” and select “CEOL carino” for “Select a device for sound output”.

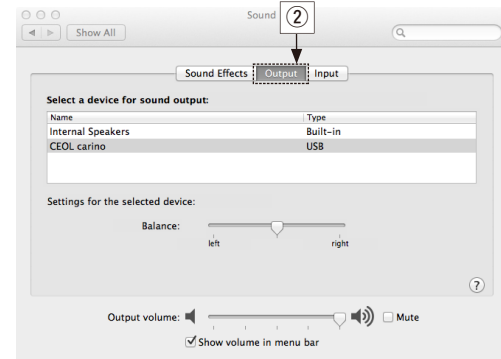



5 Plays back audio on the computer.

The speakers output music from the computer.

NOTE

- Perform operations such as playback and stop by using the player software on the computer.
- You can also adjust the volume level and equalizer on the computer.
- When the audio output format settings are changed on the computer, audio is temporarily interrupted.
- When this unit is in operation, no audio is output from the speakers for the computer.
- When the player software is running on the computer and you disconnect this unit from the computer, the player software may freeze. Make sure to exit the player software before disconnecting this unit from the computer.
- When an error occurs on the computer, disconnect the USB cable and restart the computer.
- Use a 3m or less cable to connect this unit to the computer.

Listening to music via a analog connection (ANALOG IN)

- 1 Press  to turn on power to this unit.**
The power indicator is lit.
- 2 Touch  to switch the input source to “ANALOG IN”.**
 appears on the display.
- 3 Play back music on the connected device.**
The speakers output music from the connected device.



Listening to music on a Bluetooth device

You can listen to music wirelessly by connecting this unit to a Bluetooth device via Bluetooth.

■ Pairing

Pairing (registration) is an operation that is required in order to connect a Bluetooth device to this unit using Bluetooth. When paired, the devices authenticate each other and can connect without mistaken connections occurring.



When using Bluetooth connection for the first time, you need to pair this unit and the Bluetooth device to be connected. This unit can store pairing information for a maximum of 8 devices.

NOTE

You cannot simultaneously output music from multiple Bluetooth devices.

■ How to establish a Bluetooth connection

There are three types of Bluetooth connection methods. Use an appropriate type depending on your environment.

- Case 1 Pairing with this unit for the first time
( p. 27)
- Case 2 Connecting a Bluetooth device that this unit performed pairing for before
( p. 29)
- Case 3 Connecting a Bluetooth device with the NFC function via NFC
( p. 30)



■ Case 1: Pairing with this unit for the first time

1 Turn on the Bluetooth function on the Bluetooth device.

- For details, see the owner's manual for your Bluetooth device.

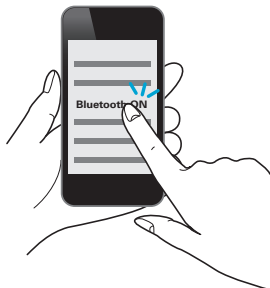

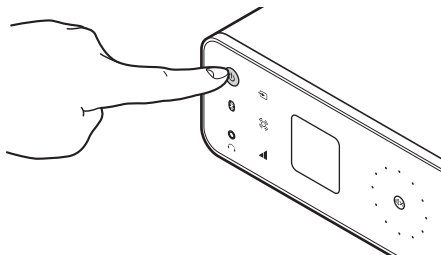

2 Press to turn on power to this unit.

The power indicator is lit.



3 Touch for 3 seconds or longer.

The  indicator and  on the display flash fast and this enters the pairing mode.

- When you touch  for the first time after purchase, this unit automatically enters the pairing mode.

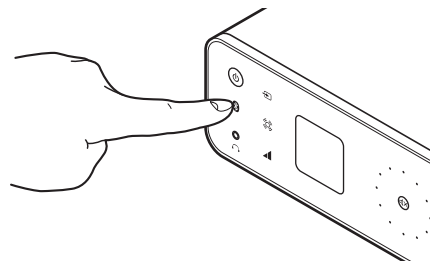

4 Select “CEOL carino” from the list of devices displayed in the screen on the Bluetooth device.

When the pairing completes and the Bluetooth connection is established, the  indicator on the display, which was flashing, is lit.

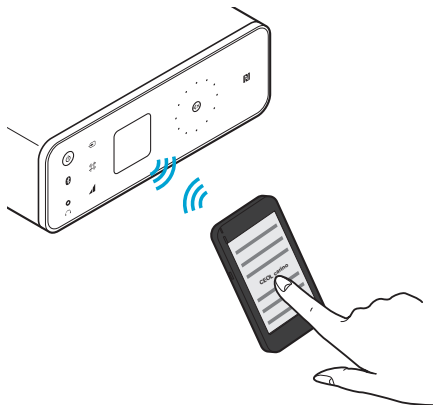



- When “CEOL carino” is not displayed in the screen on the Bluetooth device, search for devices on the Bluetooth device.
- When you are prompted for a pass key in the screen on the Bluetooth device, enter “0000”.

5 Play back music on the Bluetooth device.

The speakers output music that the Bluetooth device is playing back.



- Adjust to the appropriate volume level.
- When the pairing fails, retry from step 3.
- To perform pairing for another Bluetooth device, repeat steps 3 to 5 for each device you want to perform pairing for.
- When no Bluetooth device is connected,  appears on the display with a reduced brightness and  flashes slowly.

NOTE

- The pairing mode on this unit lasts for approx. 5 minutes. When the pairing mode on this unit is canceled before the pairing is completed, retry from step 3.
- This unit cannot perform pairing against a Bluetooth device with a pass key other than “0000”.



■ Case 2: Connecting a Bluetooth device that this unit performed pairing for before

- 1 Turn on the Bluetooth function on the Bluetooth device.**
 - For details, see the owner's manual for your Bluetooth device.
- 2 Select "CEOL carino" from the list of devices displayed in the screen on the Bluetooth device.**

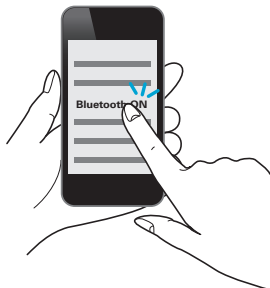

Power to this unit is automatically turned on and this unit attempts to establish the Bluetooth connection. When the Bluetooth connection is established, the  indicator on the display, which was flashing, is lit.

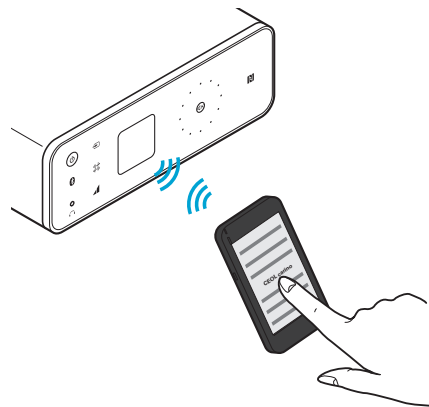

- 3 Play back music on the Bluetooth device.**

The speakers output music from the Bluetooth device.





■ Case 3: Connecting a Bluetooth device with the NFC function via NFC

You can just touch this unit with a Bluetooth device to turn on power to this unit and perform pairing or establish a connection between this unit and the Bluetooth device.

1 Turn on the NFC function on the Bluetooth device.

- For details, see the owner's manual for your Bluetooth device.

2 Touch **N** on this unit with the NFC antenna part on the Bluetooth device.

Power to this unit is turned on and the  indicator on the display flashes and this unit attempts to establish the Bluetooth connection. When the Bluetooth connection is established, the  indicator on the display, which was flashing, is lit.

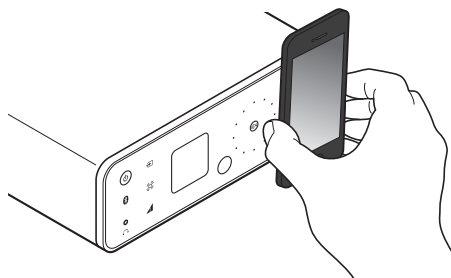

- Complete operations as instructed by the Bluetooth device.



3 Play back music on the Bluetooth device.

This unit outputs music from the Bluetooth device.



- When you touch the N mark () on this unit with the Bluetooth device that is playing back music, this unit outputs that music.
- Touch the N mark () again during the Bluetooth connection to disconnect the connection.
- When you touch the N mark () with a different Bluetooth device during the Bluetooth connection, this unit stops playing back for the currently connected Bluetooth device and connects to the newly touched Bluetooth device.

NOTE

- Before establishing a NFC connection, cancel the lock function on the Bluetooth device.
- When you touch this unit with a Bluetooth device, do so softly.



■ Simultaneously connecting multiple Bluetooth devices (multi point function)

This unit can only output music from one connected Bluetooth device, but up to 3 Bluetooth devices can simultaneously be connected. ("Listening to music on a Bluetooth device" (🔗 p. 26))

If frequently used devices are connected, it is useful for switching the playback device because you do not have to reconnect them. Perform pairing for devices you want to connect to beforehand.

Audio signals ---

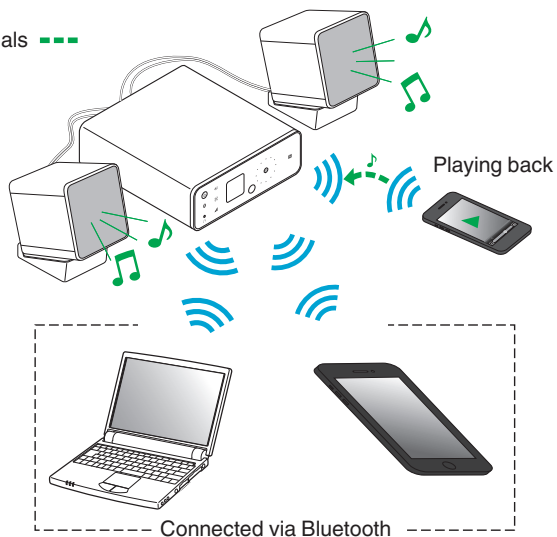

■ Switching the playback device

- 1 Stop or pause the device that is currently played back.
- 2 Play back the device that you want to output music from.



Turn the power of this unit to standby before turning the Bluetooth function of the Bluetooth device off.



Convenient function menu

Wide Sound function

You can use the Wide Sound function to enjoy more spatial sound.

1 Touch .

 appears on the display.

Auto Volume Adjust function

Music sources on the Internet such as streaming music distribution services and YouTube have various volume levels. It is troublesome to adjust the volume level each time you switch the source. This function automatically adjusts to about the same volume level when you switch to a music source with a different volume level.

1 Touch .

 appears on the display.

NOTE

When you use the Auto Volume Adjust function, set to the maximum volume level on the playback device. If the volume level on the playback device is small, this unit may not be able to recognize the volume level difference between the playback sources, making the Auto Volume Adjust function useless.



Setting the auto standby mode

You can configure this unit to automatically switch to standby when you do not operate this unit for approx. 15 minutes with no audio input. At time of purchase, this mode is set to “On”.



Turning the display on/off

You can turn off the display.

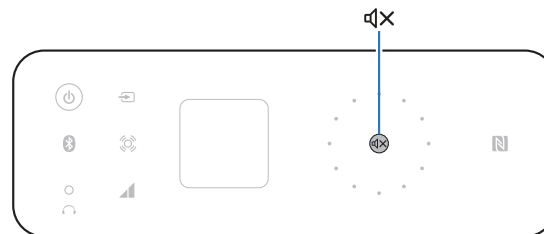

Turning the auto standby mode off

- 1 Press **⏻** on this unit for 5 seconds or longer.
“Auto Standby Off” appears on the display.

Turning the display off

- 1 Press **⏻** for 5 seconds or longer.
“Display Off” appears on the display.

Turning the auto standby mode on

- 1 Press **⏻** on this unit for 5 seconds or longer.
“Auto Standby On” appears on the display.

Turning the display on

- 1 Press **⏻** for 5 seconds or longer.
“Display On” appears on the display.



You can also press **⏻** on the remote control unit for this operation.



You can also press **⏻** on the remote control unit for this operation.



■ Contents

Tips

I want to turn on power to this unit from a Bluetooth device	35
I want to switch the connection to a different Bluetooth device	35
I want to connect to an NFC enabled device via NFC	35
I want to enjoy more spatial sound	35
I want to use speakers other than the supplied ones	35
I want to turn off the display	35

Troubleshooting

Power does not turn on / Power is turned off	36
No sound comes out	37
Sound is distorted or interrupted, or noise occurs	38
Files on a computer cannot be played back	38
The input source does not switch	39
Paring fails	39
NFC connection fails	39
Operations cannot be performed through the remote control unit	40



Tips

I want to turn on power to this unit from a Bluetooth device

- Once you perform pairing between this unit and a Bluetooth device, you can turn on power to this unit by operating the Bluetooth device. Select “CEOL carino” from the list of Bluetooth devices to turn on power to this unit.

I want to switch the connection to a different Bluetooth device

- This unit can only output music from one connected Bluetooth device, but up to 3 Bluetooth devices can simultaneously be connected. To switch the connection easily, always have the frequently used Bluetooth devices connected. When multiple Bluetooth devices are connected and you want to switch to a different Bluetooth device, stop playback on the device that is currently played back and play back the Bluetooth device that you want to output music from. (👉 p. 31)

I want to connect to an NFC enabled device via NFC

- Enable the NFC function on an NFC enabled device, and touch the N mark (N) on this unit with the NFC device. (👉 p. 30)

I want to enjoy more spatial sound

- Touch the Wide Sound key (🌀) to turn on the Wide Sound function. (👉 p. 32)

I want to use speakers other than the supplied ones

- Connect speakers other than the supplied ones and turn off the SPEAKER OPTIMIZATION switch on the rear panel. (👉 p. 17)

I want to turn off the display

- You can turn off the light of the display. Press 🔊X for 5 seconds or longer. (👉 p. 33)



Troubleshooting

1. Are the connections correct?
2. Is the set being operated as described in the owner's manual?
3. Are the other devices operating properly?

If this unit does not operate properly, check the corresponding symptoms in this section.

If the symptoms do not match any of those described here, consult your dealer as it could be due to a fault in this unit. In this case, disconnect the power immediately and contact the store where you purchased this unit.

■ Power does not turn on / Power is turned off

Symptom	Cause / Solution	Page
Power does not turn on.	• Check whether the power cord is correctly inserted into the power outlet.	19
	• Check the connection between this unit and the power cord.	19
	• This unit is in the standby mode. Press the power button (⏻).	21
	• Use the power cord that is supplied with this unit.	19
Power automatically turns off.	• The auto standby mode is on. When approx. 15 minutes pass with no audio input, this unit automatically enters the standby mode. To turn off the auto standby mode, press the power button (⏻) for 5 seconds or longer.	33
Power turns off and the power indicator flashes in white approx. every 2 seconds.	• The protection circuit has been activated due to a rise in temperature within this unit. Turn the power off, wait about an hour until this unit cools down sufficiently, and then turn the power on again.	21
	• Please re-install this unit in a place having good ventilation.	—
Power turns off and the power indicator flashes in white approx. every 0.25 seconds.	• Check the speaker connections. The protection circuit may have been activated because speaker cable core wires came in contact with each other or a core wire was disconnected from the connector and came in contact with the rear panel of this unit. After unplugging the power cord, firmly re-twist the core wire, and then reconnect the wire.	16
	• Turn down the volume and turn on the power again.	21
	• This unit's amplifier circuit has failed. Unplug the power cord and contact our customer service center.	—



■ No sound comes out

Symptom	Cause / Solution	Page
Audio is not output.	• Check the connections for all devices.	<u>18</u>
	• Check the sound settings on the computer.	<u>23</u>
	• Insert connection cables all the way in.	—
	• Check that the covered part of the speaker cable is not inserted into the speaker terminal.	<u>16</u>
	• Check cables for damage.	—
	• Check that a proper input source is selected.	<u>22</u>
	• Check that power to this unit and the connected devices is on.	—
	• Adjust to an appropriate volume level on this unit and the connected devices.	<u>22</u>
	• To playback via a Bluetooth connection, perform pairing between this unit and the Bluetooth device.	<u>26</u>
	• The ANALOG IN connector on this unit supports 3-pole stereo mini plugs. Some smartphones and portable music players support 4-pole stereo mini plugs. Provide a connection cable that suits the specifications of the device to be connected.	—
• When the muting mode is enabled, cancel the muting.	<u>22</u>	



■ Sound is distorted or interrupted, or noise occurs

Symptom	Cause / Solution	Page
Sound is distorted or interrupted, or noise occurs.	• Adjust to an appropriate volume level on this unit and the connected devices.	<u>22</u>
	• Place the device connected via Bluetooth closer to this unit.	—
	• Place this unit away from microwaves, wireless LAN devices, etc.	—
	• Turn off and on power to Bluetooth devices.	—
	• When using the supplied speakers, check that the SPEAKER OPTIMIZATION switch on the rear panel is set to "ON".	<u>17</u>
	• When using speakers other than the supplied ones, check that the SPEAKER OPTIMIZATION switch on the rear panel is set to "OFF".	<u>17</u>
Sound is interrupted during playback of music from a computer.	• During playback of music from the computer, do not run any applications other than the player software.	—

■ Files on a computer cannot be played back

Symptom	Cause / Solution	Page
This unit is not recognized on the computer.	• Reconnect the USB cable to the USB port on your computer. When this unit is still not recognized after reconnection, connect to a different USB port.	<u>18</u>
	• Restart your computer.	—
This unit is not selected as the playback device.	• Select this unit as the playback device in the sound settings on the computer.	<u>23</u>



■ The input source does not switch

Symptom	Cause / Solution	Page
Even when I touch the input source switching key (⏮), the input source does not switch.	• Touch the input source switching key (⏮) with your finger properly.	<u>22</u>
	• Use the input source switching button (⏮) on the remote control unit to switch the input source.	<u>22</u>

■ Pairing fails

Symptom	Cause / Solution	Page
Pairing fails.	• Turn off and on power to this unit.	<u>21</u>
	• Place the Bluetooth device within 1m of this unit and perform pairing again.	<u>26</u>
	• Search for devices from the list of the Bluetooth devices.	—
	• Turn off and on power to Bluetooth devices.	—

■ NFC connection fails

Symptom	Cause / Solution	Page
NFC connection fails.	• Check that the Bluetooth device has the NFC function.	—
	• Touch the N mark (N) on this unit, checking the location of the NFC antenna on the Bluetooth device. Touch surely until the Bluetooth device responds.	<u>30</u>



■ Operations cannot be performed through the remote control unit

Symptom	Cause / Solution	Page
Operations cannot be performed through the remote control unit.	• Batteries are worn out. Replace with new batteries.	<u>5</u>
	• Operate the remote control unit within a distance of about 7 m from this unit and at an angle of within 30°.	<u>6</u>
	• Remove any obstacle between this unit and the remote control unit.	—
	• Insert the batteries in the proper direction, checking the ⊕ and ⊖ marks.	<u>5</u>
	• The set's remote control sensor is exposed to strong light (direct sunlight, inverter type fluorescent bulb light, etc.). Move the set to a place in which the remote control sensor will not be exposed to strong light.	—
	• When using a 3D video device, the remote control unit of this unit may not function due to effects of wireless communications between units (such as TV and glasses for 3D viewing). In this case, adjust the direction of units with the 3D communications function and their distance to ensure they do not affect operations from the remote control unit of this unit.	—



Resetting to factory settings

Perform this when this unit does not operate properly.

Various settings are reset to the factory default values. Make settings again.

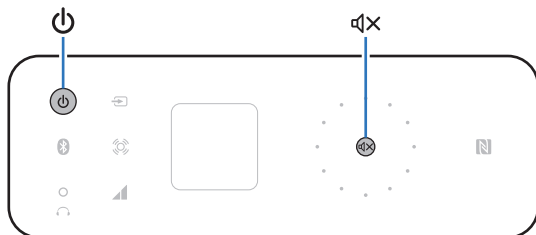

- 1** When this unit is in the standby mode, press **⏻** while holding **🔊X**.

“INITIALIZE” appears on the display and this unit restarts.

NOTE

Pairing information stored on this unit is also initialized. Perform pairing again.



Types of playable digital audio input signals

Audio signals that can be input to USB-DAC

Types of audio signals that can be input	Input signal specifications
Linear PCM (2-channel)	Sampling frequency: 44.1/48 kHz Bit length: 16/24 bit



Audio signals with a sampling frequency of 48kHz or higher are played back after downsampling is performed on the computer.

■ Computer (recommended system)

OS

- Windows® Vista, Windows 7, and Windows 8
- Mac OS X 10.6.3 or later



This unit was checked the operation using the recommended system by us, but it does not guarantee the operation of all systems.

Playing back Bluetooth devices

This unit supports the following Bluetooth profiles.

- A2DP (Advanced Audio Distribution Profile) :

When a Bluetooth device that supports this specification is connected, you can perform high quality streaming distribution of monaural and stereo audio data.

- AVRCP (Audio/Video Remote Control Profile) :

When a Bluetooth device that supports this specification is connected, you can operate the Bluetooth device from this unit.

Bluetooth communications

The radio waves broadcast from this unit may interfere with operations on medical equipment. The radio wave interference may cause a malfunction. Therefore, make sure to turn off power to this unit and Bluetooth devices in the following places.

- Hospitals, trains, airplanes, gas stands, and other places where flammable gas may occur.
- Places near automatic doors and fire alarms.



Explanation of terms

Bluetooth

Technology for near field wireless communications. This unit can connect to Bluetooth devices wirelessly. To establish a Bluetooth connection, you must perform pairing (registering) beforehand.

NFC (Near Field Communication)

Technology for near field wireless communications. You can just touch this unit with a device with the NFC function to establish a connection between this unit and the device.

Sampling frequency

Sampling involves taking a reading of a sound wave (analog signal) at regular intervals and expressing the height of the wave at each reading in digitized format (producing a digital signal).

The number of readings taken in one second is called the “sampling frequency”. The larger the value, the closer the reproduced sound is to the original.

Pairing

Pairing (registration) is an operation that is required in order to connect a Bluetooth device to this unit using Bluetooth. When paired, the devices authenticate each other and can connect without mistaken connections occurring.

When using Bluetooth connection for the first time, you need to pair this unit and the Bluetooth device to be connected.

This unit can store pairing information for a maximum of 8 devices.

Protection circuit

This is a function to prevent damage to devices within the power supply when an abnormality such as an overload, excess voltage occurs or over temperature for any reason.

If a malfunction occurs in this unit, the power indicator flashes in white and this unit switches to standby mode.

Linear PCM

Uncompressed PCM (Pulse Code Modulation) signals. Unlike lossy compression audio sources such as MP3, no audio quality or dynamic range deteriorates.



Trademark information



The Bluetooth® word mark and logos are registered trademarks owned by Bluetooth SIG, Inc. and any use of such marks by D&M Holdings Inc. is under license. Other trademarks and trade names are those of their respective owners.



The CSR logo is a trademark of CSR plc or one of its group companies.



The N Mark is a trademark or registered trademark of NFC Forum, Inc. in the United States and in other countries.



Adobe, the Adobe logo and Reader are either registered trademarks or trademarks of Adobe Systems Incorporated in the United States and/or other countries.



Specifications

■ Audio section

Rated output:	2-channel 20 W+20 W (6 Ω /ohms, 1 kHz, T.H.D. 0.7 %)
Maximum effective output power:	25 W+25 W (6 Ω /ohms, 1 kHz, T.H.D. 10 %)
Output connectors:	Speaker: 6-16 Ω /ohms (impedance) Headphones: Φ 3.5 mm jack
Total harmonic distortion rate (1 kHz, 1 W, 6 Ω/ohms):	ANALOG IN: 0.1 %
S/N ratio (10 W, 6 Ω/ohms, IHF-A):	ANALOG IN: 83 dB
Frequency response (1 W, 6 Ω/ohms):	10 Hz-20 kHz (+0.5 dB, -3 dB) (SPEAKER OPTIMIZATION: OFF)

■ USB section

Input data sampling frequency:	44.1 kHz, 48 kHz
Input data bit length:	16 bit, 24 bit



■ Bluetooth section

Communication system:	Bluetooth version 3.0
Transmission power:	Maximum 2.5 mW (Class2)
Maximum communication range:	Approx. 10 m in line of sight *
Frequency band:	2.4 GHz band
Modulation method:	FHSS (Frequency-Hopping Spread Spectrum)
Supported profiles:	A2DP 1.3/AVRCP 1.5
Supported codecs:	aptX Low Latency/AAC/SBC

* The actual communication range varies depending on the influence of such factors as obstructions between devices, electromagnetic waves from microwave ovens, static electricity, cordless phones, reception sensitivity, antenna performance, operating system, application software etc.

■ General

Power supply:	AC230 V, 50/60 Hz
Power consumption:	15 W
Power consumption in standby mode:	0.3 W

■ Speaker section

Type:	Full range/1 speaker, passive radiator type
Speaker impedance:	6 Ω/ohms
Max. permissible input:	25 W (IEC), 50 W (PEAK)
Average output sound pressure level:	82 dB (1 W/1 m)
Speaker unit:	Full range (65 mm cone type x1), passive radiator type (85 mm x1)
Cable length:	1.5 m

For purposes of improvement, specifications and design are subject to change without notice.



■ Dimensions

Unit : mm

【 This unit (PMA-N2) 】

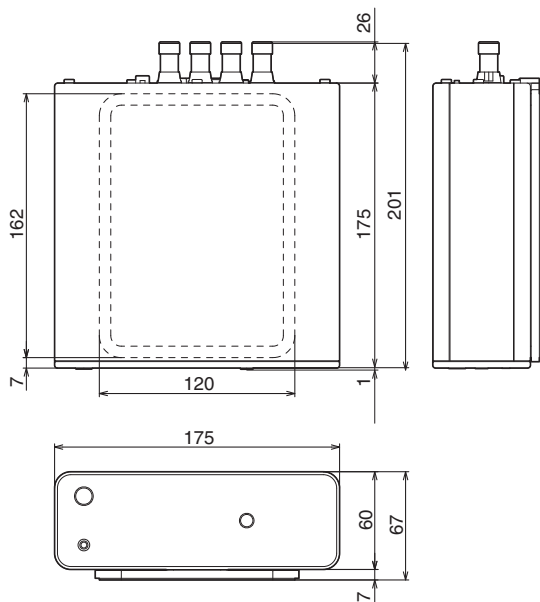

【 Speakers (SC-N2) 】

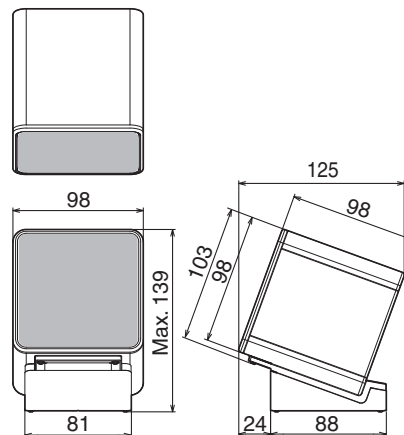

■ Weight

This unit (including the CEOL carino base): 1.6 kg

Speakers (including speaker bases and cable winders): 0.8 kg



Index

A		I		S	
Accessories	4	Initialize	41	Sampling frequency	43
Adjusting the volume	22	Installing horizontally	13	Selecting the input source	22
Auto Standby	33	Installing vertically	14	Speaker base	15
Auto Volume Adjust function	32	L		Speaker installation	15
C		Linear PCM	42, 43	SPEAKER OPTIMIZATION switch	17
Cable winder	17	Listening to music on a Bluetooth device	26	Standby	21
CEOL carino base	13, 14	Listening to music via a analog connection (ANALOG IN)	25	Stereo mini plug cable	18
Computer (recommended system)	18	M		Subwoofer cable	18
Connecting a computer	18	Multi point function	31	T	
Connecting a power cord	19	N		Troubleshooting	34
Connecting a smartphone	18	N mark	9	Turning the power on	21
Connecting a subwoofer	18	NFC function	30, 43	U	
D		P		USB cable	18
Display	10	Pairing	26, 43	W	
F		Protection circuit	43	Wide Sound function	32
Front panel	8	R			
		Rear panel	11		
		Remote control unit	12		



DENON[®]

www.denon.com

D&M Holdings Inc.
3520 10326 00AD